

# VEICHI

## AC Series General Purpose Frequency Inverter





Shenzhen Veichi Electric Co., Ltd. is a high-tech enterprise which is professionally engaged in the development, manufacturing and marketing of industrial automation control products, and committed to becoming a global leading provider of industrial automation control products and system solutions.

The company owns powerful R&D team, relatively perfect production system, independent intellectual property and manufacturing bases in Shenzhen and Suzhou. To improve our R&D strength, we keep on introducing advanced overseas technology and broadening our partnerships with first-class universities and research institutions.

The main products of Veichi Electric include a variety of Variable Frequency Drive (VFD), Servo Drive System, Photovoltaic Inverter, PLC, HMI, Automation Equipment, etc, which are widely used in industries such as oil & gas, chemical industry, ceramic, crane & hoist, metallurgy, electrical cable and wire, plastic, print and package, textile, metal work and cable, coal mining and municipal engineering. Suitable solutions and products are always ready to meet the demands and improve comprehensive competitiveness of users.

With the spirit of "Innovation is the lifeblood of Veichi", we're committed to becoming one of the leading providers of electric drives, industrial control and green energy products. Veichi has set up more than 40 branch offices in China and dozens of partners in Asia, Europe and Africa. Veichi has been named Chinese Electric Industry's Top Ten National Brands, Chinese Electric Industry Top Ten Satisfying Brands and Top Ten National Brands of Inverter Industry. Veichi products have become the first choice of many enterprises.



## Brief Introduction

### Accumulation



AC series inverter was developed in 2005, after ten years of development, more than 100 inverters have been applied to site applications and been updated for four generations. Nowadays, stable and reliable performance and easy-using functions have become the critical features of VEICHI AC series products.

### Drive Innovation



Drive for ever. VEICHI not only dedicates to improve products' reliability and functionality but also to strengthen the usability and specialized design. With excellent control performance, reliable protective functions, rich interface resources and strong extension capability, AC series products have won clients' recognition. Series inverter will start a new journey with its new appearance, heading for a new round of development channel.

## Product Review

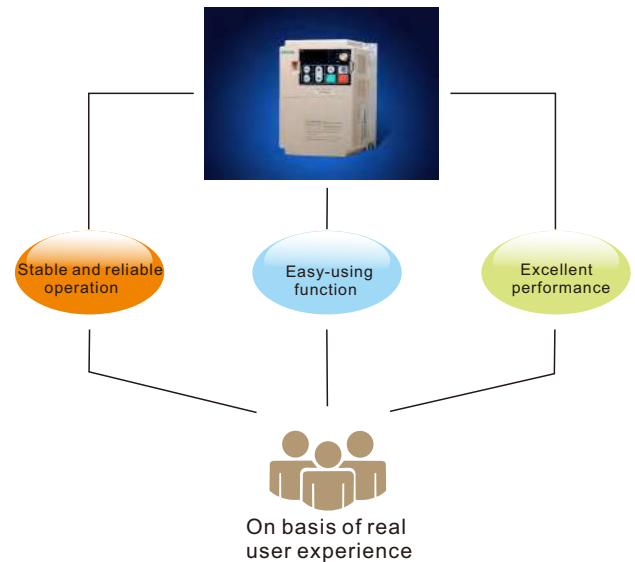

## Product Development Process

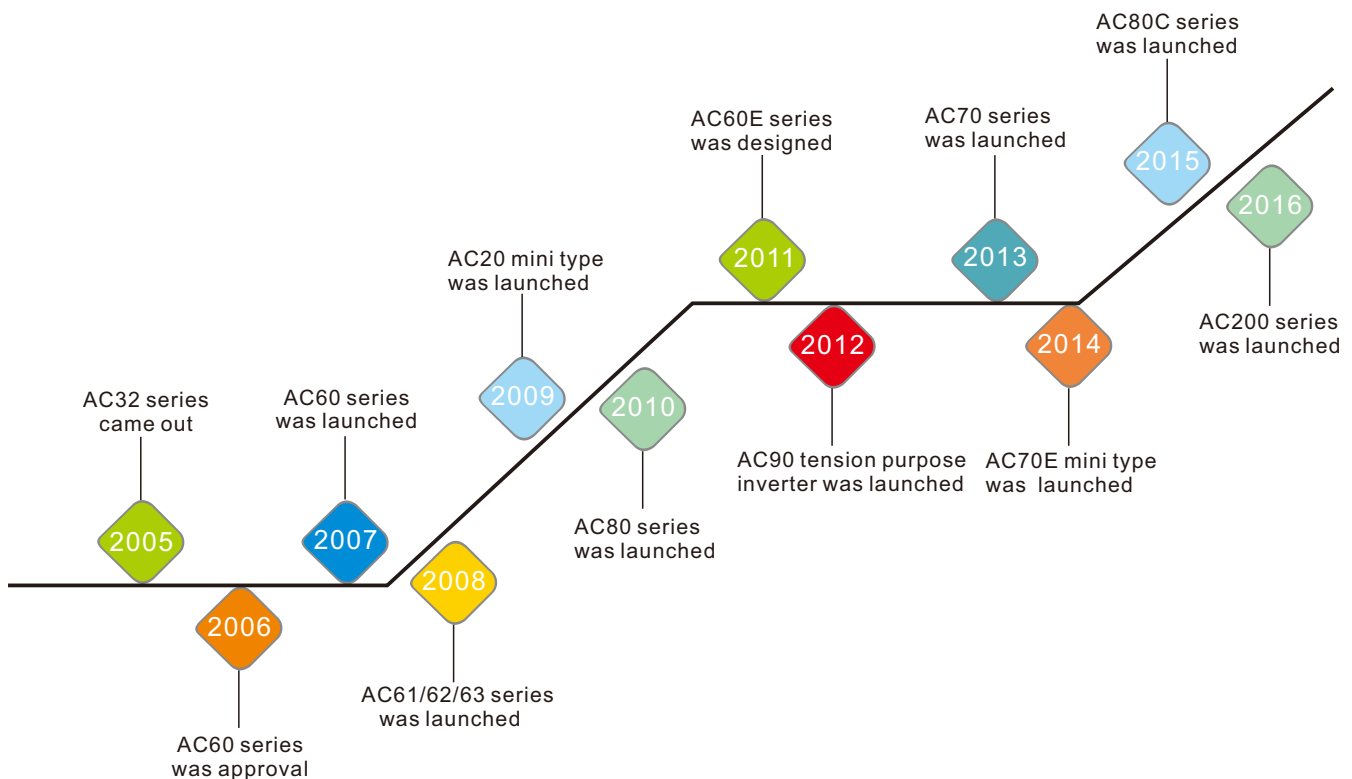

# General Purpose Frequency Inverter

## AC70 Series—General Purpose



### Product Features

1. AC70 series products are easy in installing, debugging and maintaining and are widely used.
2. High reliability and environmental adaptability.
3. Good applicability to power grid and wide voltage input range, functions of supporting AVR and grid Instantaneous stop non-stop.
4. Complete protective functions, higher hardware configuration and easy adaptability to various working conditions.
5. Anti-metallic dust design and independent duct design. PCB three anti-paint treatment.

## AC70E Series—Mini Type



### Product Features

1. Mini frequency inverter with high stability and reliability.
2. Customized design for small power motor.
3. Installation space is greatly saved by its mini volume.
4. Stable performance and low temperature rise.
5. Higher reliable and stable design requirements.

## AC200 Series—Synchronous/Asynchronous Drive



### Product Features

1. By using high performance vector control algorithm, the system has achieved synchronous asynchronous drive integration and comprehensive open loop and closed loop, featuring high speed precision, fast response and large torque at low frequency.
2. The unique synchronous motor control algorithm can detect the pole position and motor speed without encoder, realizing high-precision control.
3. Excellent impact load response capacity, fast torque response to the rapid load change, high precision in speed control and excellent limiting capacity.
4. The over-excitation function can help to achieve fast brake without external braking resistor, suitable for situations needing no frequent but fast brake.
5. Modular design requests for software and hardware have strong expansion capabilities that can be easily debugging on applications, supporting on-site firmware upgrades.

## General Specifications

		AC70 Series	AC70E Series	AC200 Series	
Power Section	Single phase 220V 50/60Hz	0.75-15KW	0.75-2.2KW	0.75-220KW	
	Three phase 220V 50/60Hz	0.75-15KW	---	0.75-220KW	
	Three phase 380V 50/60Hz	0.75-710KW	0.75-4.0KW	0.75-710KW	
Input	Allowing voltage fluctuations	Voltage : $\pm 15\%$ ; Voltage unbalance rate: $< 10V$ ;		Voltage: 320V~440V; Voltage unbalance rate: $< 3\%$ ;	
	Allowing frequency fluctuations	Frequency: $\pm 5\%$			
	Distortion rate	IEC61800-2			
Output	Output voltage	0~input voltage, Error is less than 5%			
	Output frequency range	0~320Hz	0~320Hz	0~600Hz	
	Overload capacity	150% of rated current for 1min; 180% of rated current for 10s; 200% of rated current for 0.5s			
Main Control Performance	Control mode/ starting torque	V/F control without PG	* 1.0Hz~150%	* 1.0Hz~150%	* 0.5Hz~180%
		V/F control with PG	---	---	---
		AM vector control without PG	* 1.0Hz~180%	* 1.0Hz~180%	* 0.5Hz~180%
		AM vector control with PG	---	---	* 0.00Hz~200%
		PM vector control without PG	---	---	* 2.0Hz~100%
		PM vector control with PG	---	---	* 0.00Hz~200%
		Voltage frequency departure output	---	---	*
	Speed mode	Speed control range	Vector control without PG, rated load capacity 1:100		Vector control without PG (asynchronization), rate load capacity 1:100 Vector control without PG (synchronization), rate load capacity 1:50 Vector control with PG (asynchronization/ synchronization), rated load capacity 1:1000
	Torque mode	Torque control accuracy	---		Vector control without PG: $\leq +10\%$ Vector control with PG: $\leq 5.0\%$
	Accuracy in stable speed		Vector control without PG : $\leq 1\%$ Rated synchronous speed		Vector control without PG: $\leq 0.5\%$ of rated synchronous speed Vector control with PG: $\leq 0.5\%$ of rated synchronous speed
	Torque response		Vector control without PG: $< 20ms$ Vector control with PG: $< 10ms$		
	Frequency accuracy		Digital setting: maximum frequency $\times\pm 0.01\%$ Analog setting: maximum frequency $\times\pm 0.2\%$		
	Frequency resolution		Digital setting: 0.01Hz Analog setting: maximum frequency $\times 0.05\%$		
Carrier frequency		0.7~15.0kHz		0.7~16.0kHz	
Control Circuit Terminal	Power		1 way : DC 10V/ 50mA 1 way : DC 24V/100mA		
	Input	Current mode	AS:DC 0-20mA/50 $\Omega$		
		Voltage mode	2 way VS:DC 0-10V	1 way VS:DC 0-10V	
		Voltage/ current mode	---	---	1 way AI:DC 0-10V/0-20mA
		Digital quantity	6 way X terminal : DC 30V/80mA		
	Pulse quantity	1 way PUL: 0.0-50.00KHz	---	1 way PUL: 0.0-50.00KHz	
	Output	Analog quantity	AO1: DC 0-10V/ 0-20mA/4-20mA AO2: DC 0-10V/ 0-20mA/4-20mA/ 0-50KHz	AO: DC 0-10V/ 0-20mA/4-20mA	AO1:DC 0-10V/0-20mA/4-20mA AO2:DC 0-10V/0-20mA/4-20mA/0-50KHz
		Digital quantity	2 way Y terminal : DC 30V/50mA	1 way Y terminal : DC 30V/50mA	1 way Y terminal : DC 30V/50mA
Relay type		1 open 1 close: 3A/240VAC 5A/30VDC	1 open: 3A/240VAC 5A/30VDC	2 open 2 close: 3A/240VAC 5A/30VDC	

# AC70 Series- General Purpose



## Product Overview

AC70 general purpose vector control inverter is a high performance inverter developed by VEICHI. The leading flux algorithm and modular design are adopted to realize high performance and high precision motor drive control, which can meet the needs of different situations. In addition to the general applications, AC70 is especially suitable for industries like air blower, water pump and air compressor.

## Product Frequency Range

220V single phase: 0.75 ~15KW; Three phase: 0.75~ 15KW  
380V three phase: 0.75 ~ 710KW

## Product Features

### Two Drive Control Modes

#### ◎ V/F control

The control mode is used in all variable speed control that does not require fast response speed and high-precision control and in situations where one inverter connecting multiple motors; and the mode can be used when the motor parameters are not clear or can not use the self-study.

#### ◎ Vector control without PG

This mode is used in all variable speed control, when the high-accuracy speed control is needed, please set to this mode, which has rapid torque response, and a large torque can be obtained in low speed running.

### Rich Self-study Function

Rotating self-study and static self-study can be selected through parameter settings	
Static self-study	The mode is most suitable when motor and load can not be disengaged, when motor and gear box is connected to make accurate electrical parameters after self-study, thereby obtaining a high starting torque, high-speed, and high-precision control.
Rotating auto tuning	This mode is most suitable when motor and load can be disengaged or no-load running situation. So the mechanical equipment can obtain high starting torque, high-speed, and high-precision control.



## Speed Tracking Mode

In light load one inverter can drive several motors to start tracking and to optimize the hardware and software tracking function, in which case the speed tracking precision and reliability are much higher.

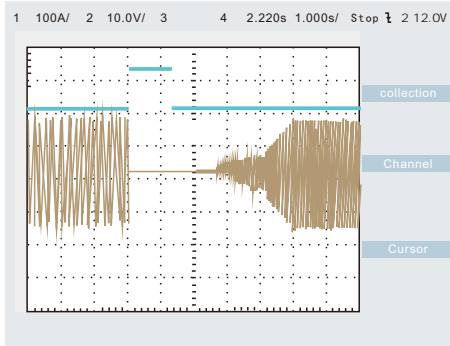

Software Tracking

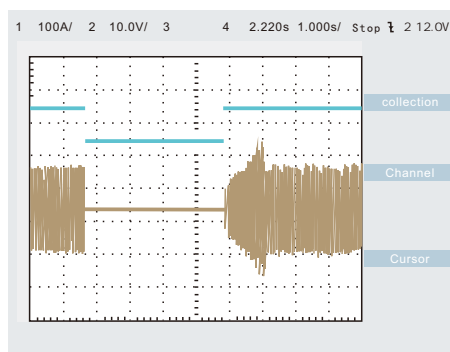

Hardware Tracking

## Over-excitation Function

- ⊙ No need to increase peripheral resistance braking and other accessories, to achieve rapid braking effect and improve product usability.
- ⊙ It can effectively inhibit the decelerating bus voltage rises, to avoid frequent reported overvoltage fault, while achieving rapid braking power to realize fast stop.

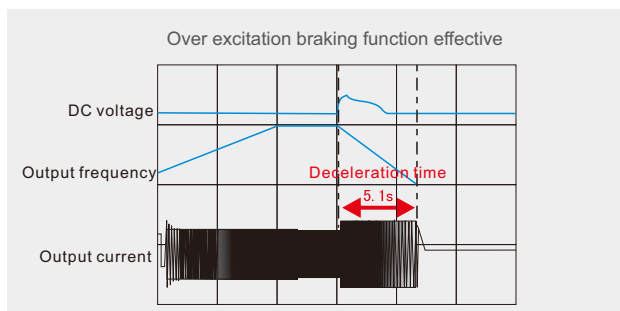
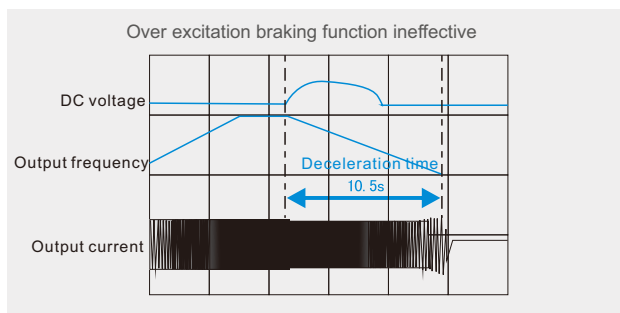

## Professional instantaneous stop without power off algorithm to deal with interference electricity of power grid

In a lighter load or high inertia loads instantaneous power compensation can be implemented.

- ⊙ Eliminating the need for UPS (uninterruptible power supply), and other special equipment. When low voltage is detected, automatic instantaneous power compensation can be implemented.
- ⊙ Search free-running state speed, easily re-start to improve the reliability of the whole system.

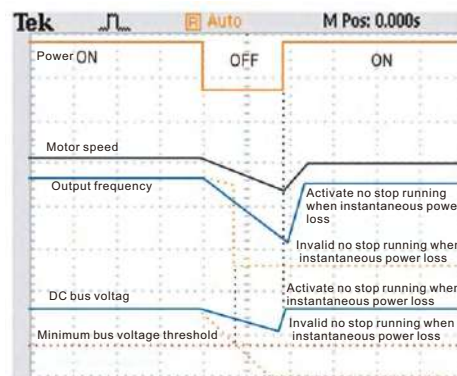

## Random Carrier Function

Random carrier function can effectively reduce motor noise and suppress Inverter interference on external devices.

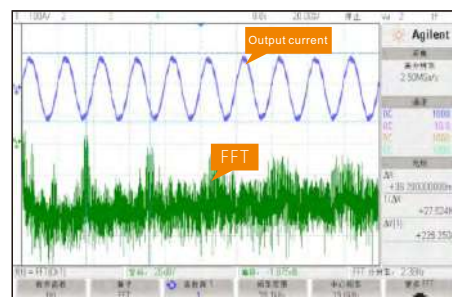

Random carrier OFF

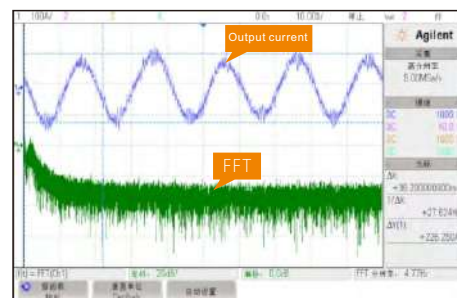

Random carrier ON

## Oscillation Suppression

When the motor can not run properly with significant oscillations, turn on this feature, the oscillation suppressing effect would be significantly improved.

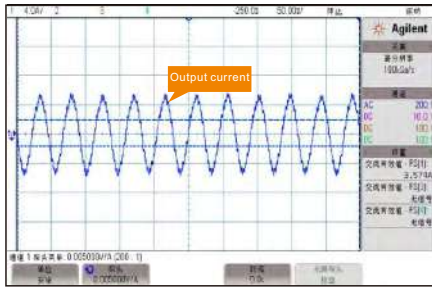

VF open oscillation suppression

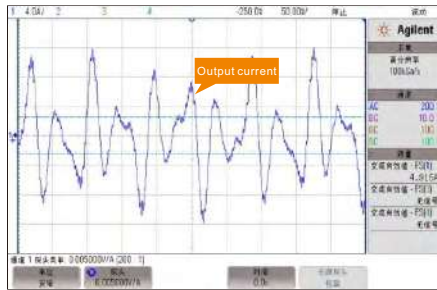

Current wave under oscillation

### Multiple V/F Curves Settings

- ⊙ Five curve settings :
  - Constant torque curve for ordinary constant torque load;
  - Customized torque curve for water extractor, centrifuge load;
  - Square torque curve for blower and water pump load;
- ⊙ Adjustable five points for curve ;
  - The most suitable curve can be set according to the torque characteristic of the equipment;
  - Achieving better energy-saving effect if matching with the best excitation control.

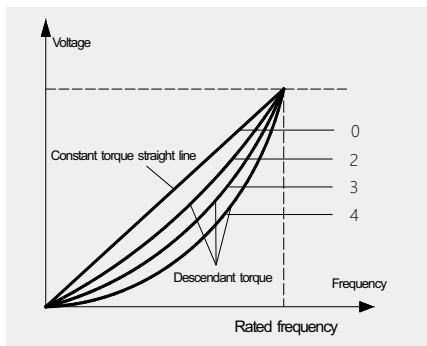

V/F curve diagram

- 0: Constant torque curve
- 2: Descendant torque curve ( 1.3 times )
- 3: Descendant torque curve ( 1.7 times )
- 4: Descendant torque curve ( 2.0 times )

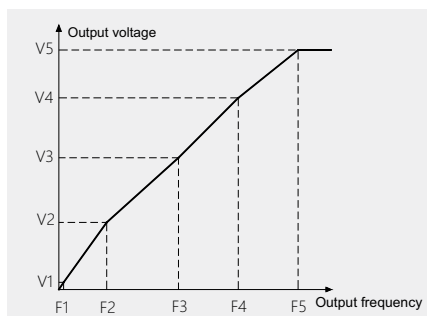

Customized V/F curve diagram

- V1: 3%      V3: 55%
- F1: 1.00HZ    F3: 25.00HZ
- V2: 28%     V4: 80%
- F2: 10.00HZ   F4: 37.50HZ
- V5: 100%    F5: 50HZ

### Standard Swing Frequency Function

- ⊙ The main purpose is to avoid wobble when winding and reduce static electricity.
- ⊙ The thread is better than the thread produced by equipment without this feature, which improves the quality and production efficiency of the product.

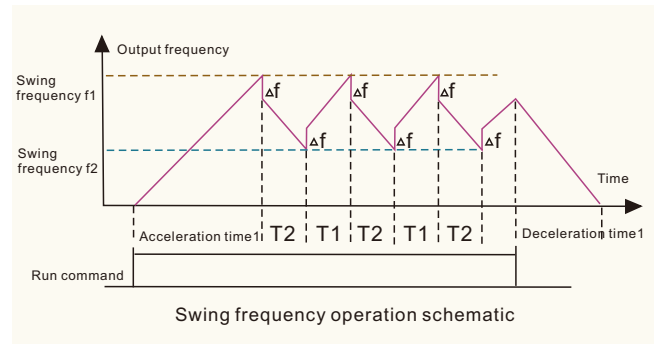
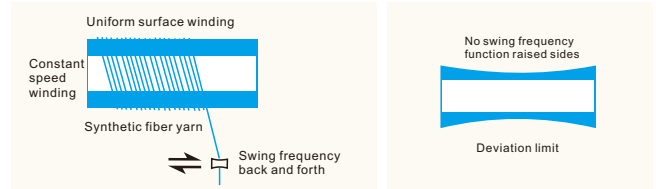

### Multiple PID Controls

PID control is divided into ordinary PID and closed-loop pressure special PID with a broader scope and more specific feature.

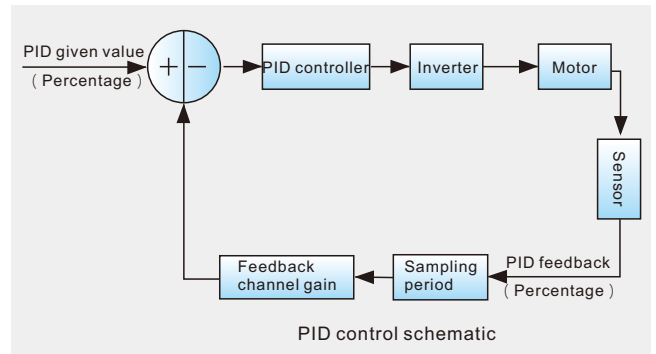

PID control schematic

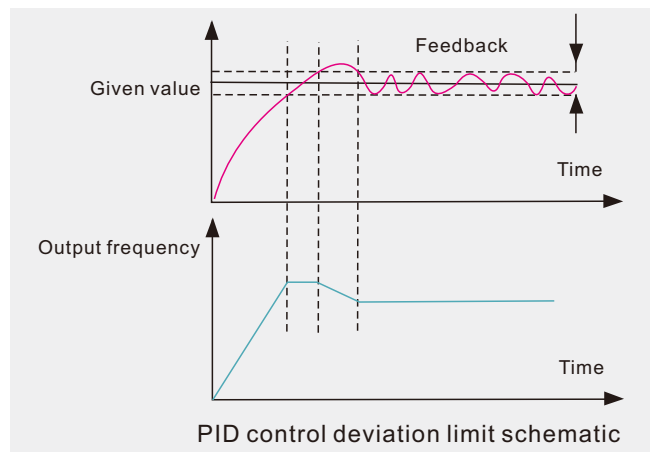

PID control gain deviation limit schematic



## Energy Saving

- ⊙ A new generation of energy-saving operation, the use of energy-saving inverter control can achieve high efficiency operation of induction motor.
- ⊙ In operation, the drive automatically calculates the optimum output voltage and supplies it to the load in order to achieve the purpose of saving energy.

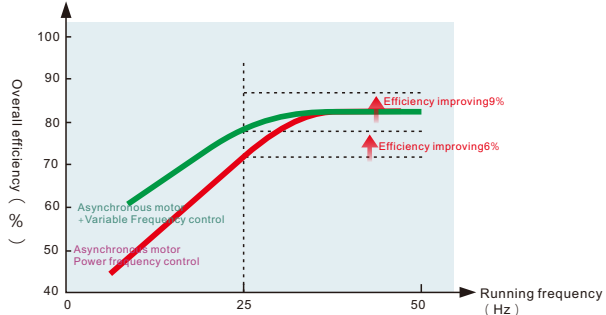

380V 4.0KW Application cases of fans and pumps

## Available DC Power Supply

- ⊙ DC power supply can be used directly, especially for the common DC bus program and EPS powersupply.
- ⊙ Energy efficient, environmentally friendly and economic.

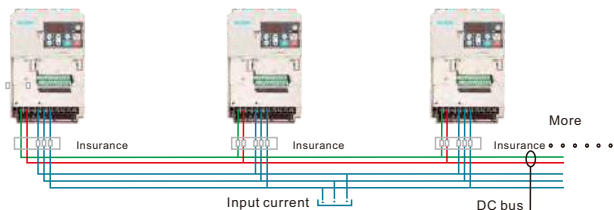

## Communication Method

- ⊙ Standard RS485 communication, support PROFIBUS-DP communication protocol.
- ⊙ Convenient for the achievement of PC and PLC connection to realize remote monitoring.

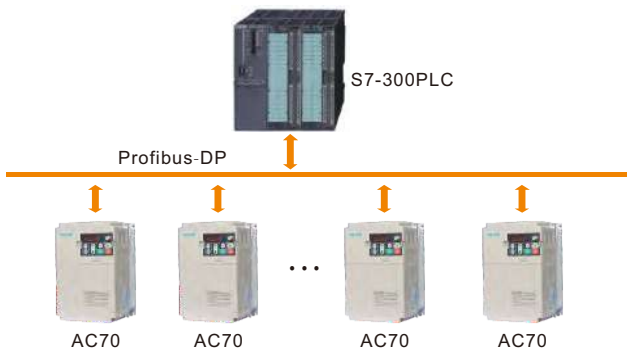

## Mounting Mode

- ⊙ Full range of DC fan, easy to replace, longer life span. Available for penetrating installation, strong adaptability.
- ⊙ Cabinet machine adopts up and down design with standard chokes mounted on the base so that the cooling is better, improving the life of the machine, at the same time the wiring is more beautiful.

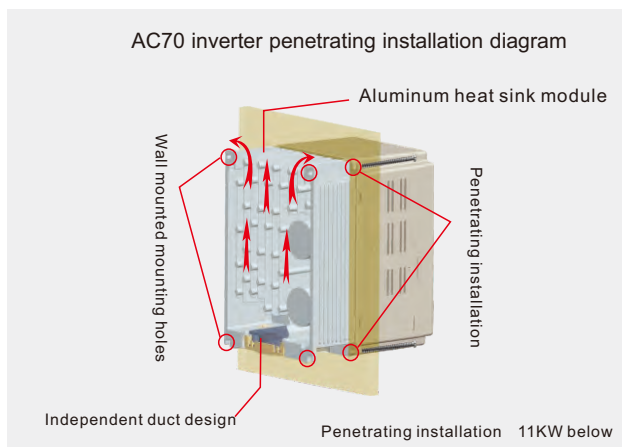

## Environmental Resistance Design

- ⊙ Three anti-treatment  
PCB three anti-treatment: anti-moisture, anti-salt and anti-fungal.
- ⊙ Protection class  
Protection class is IP20, higher protection class products can be customized.
- ⊙ Moisture resistant, dust resistant, vibration-resistant and environmental-friendly products.

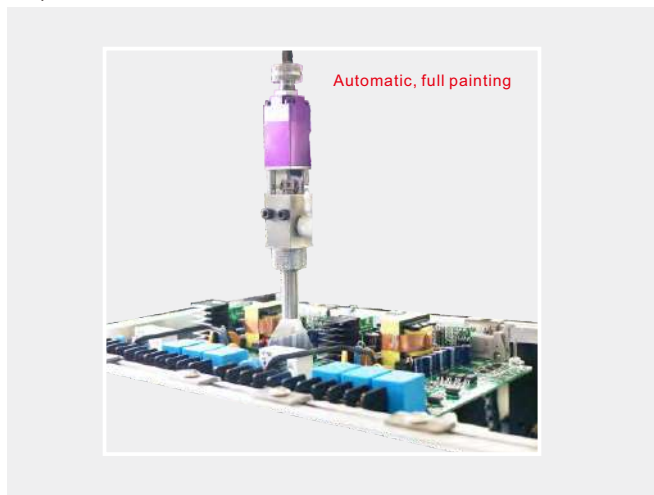

## Application Areas

### Fans and Pumps

- ⊙ Low impact to power grid, good energy-saving effect and long service time.
- ⊙ It achieves stepless speed regulation of motor and the continuous stable speed change will reduce mechanical vibration and noise.
- ⊙ Built in pressure closed-loop PID can ensure stable pipe pressure.
- ⊙ The system is with high stability and strong reliability.



### Textile Machinery

- ⊙ Smooth start, good speed acceleration and deceleration and low impact.
- ⊙ Multi-channel frequency given channel, standard swing function and higher speed stability accuracy.
- ⊙ Improve production efficiency and promise product quality.
- ⊙ Widely used in textile machinery such as sizing machine, glue machine, photographic weft machine, embroidery machine and roving machine.



### Compressor / Air compressor

- ⊙ Various combinations of the double channel frequency given, ensuring convenient system function.
- ⊙ Built-in advanced PID algorithm, fast response, high constant pressure precision.
- ⊙ Meet the system requirements of starting and operating in heavy load situation.
- ⊙ Overall protection from the frequency inverter, motor to the outer equipment.



### Wood Working Machinery

- ⊙ High speed stability/ smooth speed acceleration and deceleration.
- ⊙ Unique control algorithm and fast brake without braking resistor.



### Glass Machinery

- ⊙ Stable system and low fault rate.
- ⊙ Smooth transmission and easy operation.
- ⊙ Smooth soft start which can avoid electrical and mechanical shocks to ensure the service life.



### Industrial Washing Machine

- ⊙ large starting torque as the clothes have absorbed water.
- ⊙ The powerful torque and slip compensation of AC70 ensures the stability of washing process.
- ⊙ Small speed fluctuation during the eccentric status.
- ⊙ Strong environmental adaptability and stable running in severe environment such as high humidity and high temperature.



# AC70E Series - Mini Type



## Product Overview

AC70E series inverter is a new generation of high-performance general-purpose inverter; the product has advanced control method to achieve high torque, high accuracy, high reliability and wide speed drive. Products built-in PLC, PID adjustment, programmable input and output terminals, RS485 interfaces, analog input and output, and other rich control functions. These functions provide highly integrated solutions for engineering and special industry automation applications.

## Product Frequency Range

220V single phase: 0.75 15KW  
Three phase: 0.75 ~ 15KW

## Product Features

### Superior Design Concept

#### Advanced control algorithms

Vector control without PG (SVC), V/F control mode and improved PWM output.

#### Humanization design

Wide voltage input range, ensuring that products meet the needs of the user site.

#### Convenient operation

Out access is standard, potentiometer keyboard, plug and play, supporting parameter copy.  
Complete fault protection, fault history query support, rapid positioning.

#### Rich features

Multi speed and simple PLC, PID.  
Wide voltage input range, ensuring that products meet the needs of the user site.

#### Environmental resistance design

Three anti-treatment: PCB three anti-paint treatment: anti-moisture, anti-salt, anti-fungal.

Protection class is IP20, higher protection class products can be customized.  
Moisture resistant, dust resistant, vibration-resistant reinforced products.

### Optimized Structural Design

Adopt leading modular design concept, compact structural layout and professional thermal simulation design.  
Compared with other series of the same power mode, mini types greatly save the installation space.

#### Structure Comparison Diagram

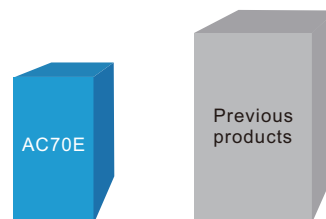

Area reduced by 43% and volume reduction of 50%.

## Excellent Vector Control Performance

Realizing AC motor decouple and motor vector control. In PG without vector torque control mode, torque control accuracy can up to 5%. Motor four-quadrant runs; torque, current, speed and DC bus voltage fast response, and the motor runs smoothly.

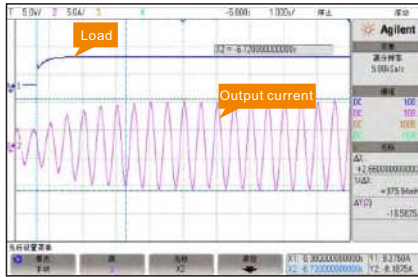

Outputting large current at 2Hz, the motor does not stall

## Advanced Thermal Simulation

It adopts advanced and accurate thermal simulation software to ensure the thermal reliability of the whole machine.

When designed AC70, the technical team considered various application areas. After rigorous thermal simulation tests, they reduced the overall volume while ensuring the small temperature rise.

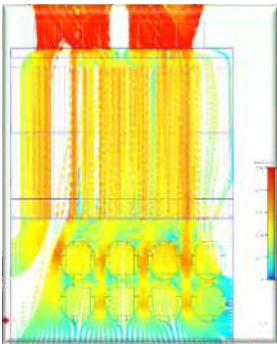

Air flow effect diagram

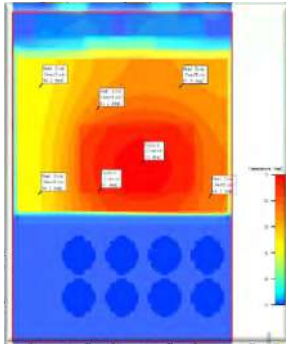

Temperature distribution diagram

## Speed Tracking Mode

In light load one inverter can drive several motors to start tracking and to optimize the hardware and software tracking function, in which case the speed tracking precision and reliability are much higher.

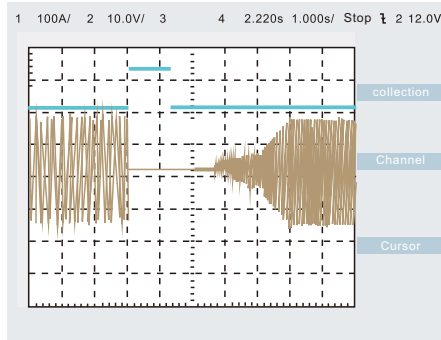

Software tracking

## Smart AVR Function

When the automatic voltage regulator function is invalid, the output voltage would change with the input voltage. When the automatic voltage regulator function is valid, as long as the minimum input voltage fluctuation is greater than the programmed output voltage (motor rated voltage), the output voltage can be substantially maintained at the set value.

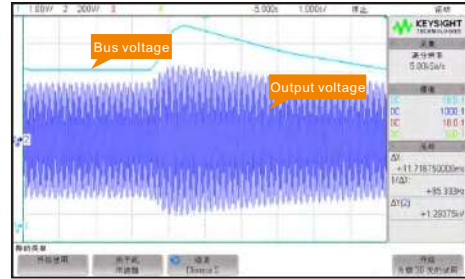

Smart AVR function invalid

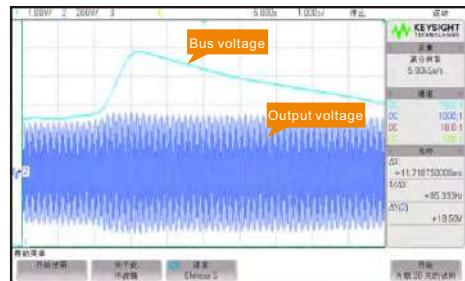

Smart AVR function valid

## Random Carrier Function

Random carrier function can effectively reduce motor noise and suppress inverter interference on external devices.

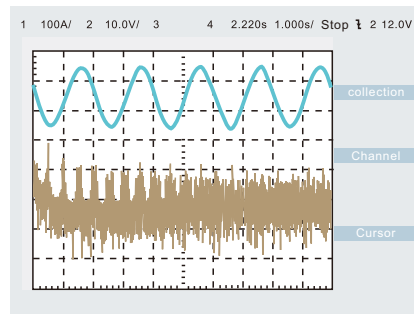

Interference signal under fixed-carrier is strong

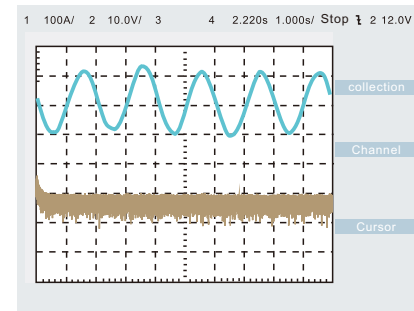

Noise can be effectively reduced in random carrier



## Excellent Protective Functions

### Perfect fault protection

- ⊙ History alarm records and inquiries, fast positioning.
- ⊙ Pre-alarm function, early warning, non-stop operation.
- ⊙ Support phase loss derating operation.
- ⊙ Support mechanical load damage alarm.
- ⊙ Protections for over voltage, over current, phase loss, overheating and overload.

### Rich software protections

The frequency converter fault protection times will be reduced by advanced drive algorithm and precise control on output voltage and current.

### Over voltage suppression

During the deceleration process, by adjusting output frequency, it can avoid over voltage of frequency inverter caused by fast acceleration.

### Over current suppression

During the acceleration process, by adjusting the output frequency, it can avoid over current of frequency inverter caused by over fast acceleration.

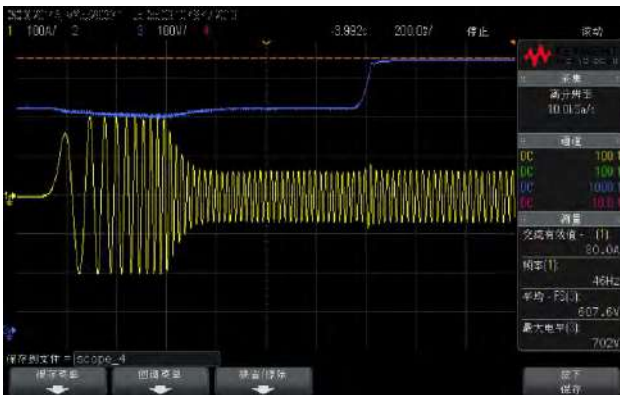

## Comprehensive Hardware Protection

Has functions of output to ground short-circuit protection, internal buffer relay protection, fan drive circuit protection, external 24VDC DC short circuit protection and motor overload protection that can achieve overall protection from the frequency inverter inner parts to the external equipment.

## Excellent Energy Saving Function

With the new generation of energy-saving control technology, the induction motor can be operated efficiently;

The excitation current can be reduced on the load current; the energy saving situations can be adjusted on its loading capacity.

Maximize the motor efficiency;

Reduce motor loss and energy loss.

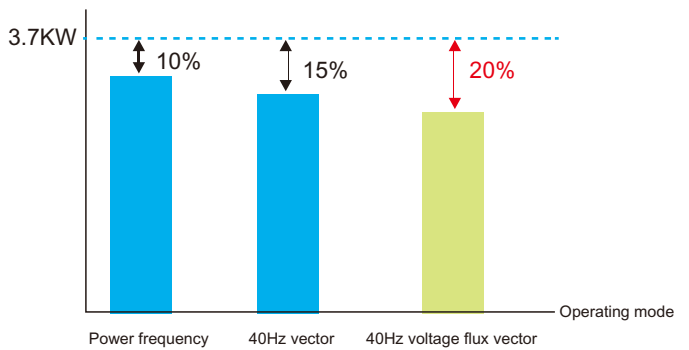

Energy-saving comparison

## Updated EMC Design

The unique and convenient grounding design will effectively weaken electromagnetic interference.

## Abundant Application Functions

The rich software functions will satisfy customer's specific industry needs.

Function	Effect
Acceleration and deceleration curve	Two kinds of acceleration and deceleration modes, four kinds of acceleration and deceleration times, time unit 0.1S, the longest 6500.0s.
Instantaneous power off non-stop	Deal with the phenomenon of instant grid voltage drop, this function can keep the equipment running continuously without shutdown in the effective time and ensure the continuity of equipment operation.
Simple PLC	The frequency inverter can automatically switch the running direction and frequency according to the time set by the simple PLC to meet the requirements of the field process.
Virtual I / O	Can be simulated by the internal virtual terminal, actually the X / Y terminal, wiring eliminates the actual terminal wiring; Save the actual number of terminals, reduce the external wiring.
Power off and restart	After the power is restored, frequency inverter can automatically start according to the set time.
Speed tracking	Software speed tracking can detect the motor speed from the current, and then output automatically according to the set value.

## Application Areas

### Domestic Fans and Pumps

- ⊙ Good energy saving effect and long service life.
- ⊙ The motor speed can be continuously and steadily changed with smaller mechanical vibration and lower noise.
- ⊙ Built in pressure closed-loop PID can ensure stable pipe pressure.
- ⊙ High stability, strong reliability and complete protect functions.



### Food Machinery

- ⊙ Increase efficiency and reduce cost.
- ⊙ Wide speed change range and strong anti-overload capability.
- ⊙ Achieve software control.



### Packing Machinery

- ⊙ High stable speed accuracy and fast response performance.
- ⊙ Small volume, low noise and rich functions.



### Automated Assembly Line

- ⊙ Powerful communication function to facilitate centralized control.
- ⊙ Strong resistance to current shock.





# AC200 Series Synchronous/ Asynchronous Drive



## Product Overview

AC200 is the latest high performance vector frequency inverter developed by VEIHC I. As adopting the leading field oriented vector control technology, the inverter has compatible functions of synchronous and asynchronous motor control, supporting three control modes on speed, torque and position. When improving the products' reliability and functions, we also strengthen the usability and specialized industry design. AC200 will win client's recognitions by its excellent control performance, reliable protective functions, rich port resources and strong expansion capacity.

## Product Frequency Range

220V	single phase: 0.75~ 15KW; Three phase: 0.75~ 15KW
380V	three phase: 0.75~ 710KW

## Product Features

### Hardware Upgrades

1. Full range of three-phase current detection output can realize the short circuit protection.
2. Higher bus capacitor configuration, longer machine life.
3. AC80C full range of standard common DC bus design can be directly co-bus.
4. Terminal protection is complete, and control panel 24V, 10V power supply has short circuit and overload protection.
5. Full range of DC cooling fan is safe and reliable.
6. Three anti-machine design, copper plating, PCB-three paint spraying to ensure stable and reliable products;
7. Standard brake unit for products under 22KW, and standard reactor for products above 160KW.
8. Standard keyboard design supports both keyboard and parameter copy function.

### Performance Optimization

#### High stable speed accuracy

Stable speed accuracy:  $\pm 0.5\%$  (SVC),  $\pm 0.02\%$  (FVC)

#### Wide range of speed control

Speed control range: 1: 200 (SVC), 1: 1000 (FVC)

#### Fast response

Vector control without sensor, torque response  $< 20\text{ms}$ .

Vector control with sensor, torque control response  $< 5\text{ms}$ .

#### Large starting torque

Vector control without sensor: 150% of rated torque at 0.5Hz.

Vector control with sensor: 180% of rated torque at 0Hz.

## Support Multiple Motor/ Load Types

( 1 ) It can drive all kinds of motors: ordinary asynchronous motor, frequency conversion motor, AC servo motor, various synchronous motor, high speed motor and electric spindle.

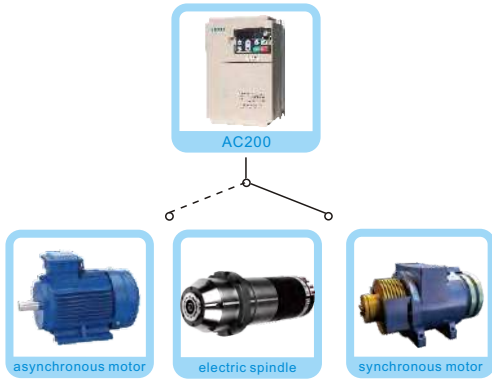

( 2 ) Realize operation under V/F complete separation and semi separation, and meet power supply requirements of variable frequency and variable voltage.

## Support Multiple Control Modes

- Asynchronous motor control mode: V/F control
- High performance vector control with speed sensor;
- High performance vector control without speed sensor;
- Synchronous motor control mode: high performance vector control with speed sensor;
- High performance vector control without speed sensor;
- Other control mode: voltage frequency separation output

Control mode	Speed control	Torque control	Position control	Suitable motor
V/F	v	x	x	Asynchronous motor
High performance vector without PG	v	v	x	Asynchronous permanent magnet motor
High performance vector with PG	v	v	v	Asynchronous permanent magnet motor

## Standard Self-study Functions of Motor Parameters

It can accurately carry out the rotation or static motor parameters from self-study with easy debugging and simple operation, providing higher control accuracy and speed response.

- Rotating auto tuning**: Under this mode, the motor and load must be disengaged, it's suitable for high requirement situations for control accuracy.
- Static self-study**: Unique functions of AC200 that can achieve the same effect of rotating self-study when the motor is in static condition.



## Large Starting Torque

Under the closed-loop vector mode, the torque linearity deviation is within 3%. The stable torque output and large torque at low frequency will output 200% of rated torque at 0.0Hz. Even in ultra low speed at 0.01Hz, the system can be stable with load operation.

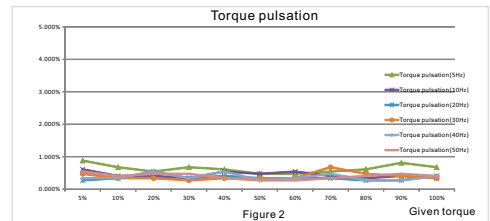
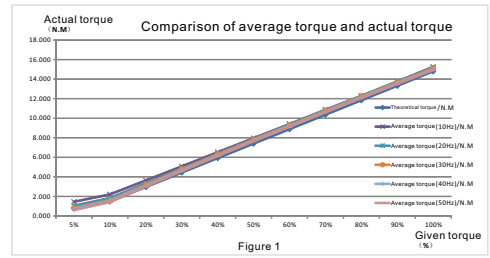

## High Speed Output Under Vector Control

Under vector control mode, the maximum frequency output can reach 600Hz and achieve high speed and high precision output within 10 times of the weak magnetic range.

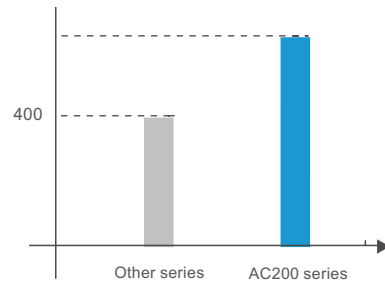

- Other series: the maximum frequency output can reach 320/400Hz under vector control.
- AC200 series: the maximum frequency output can reach 600Hz under vector control.

## Strong Overload Capacity

Adopt load curve standard integrating with G type and P type.  
 G type: 150% of rated current for 60s in 300s cycle period;  
 P type: 130% of rated current for 60s in 300s cycle period;

Current of frequency control products

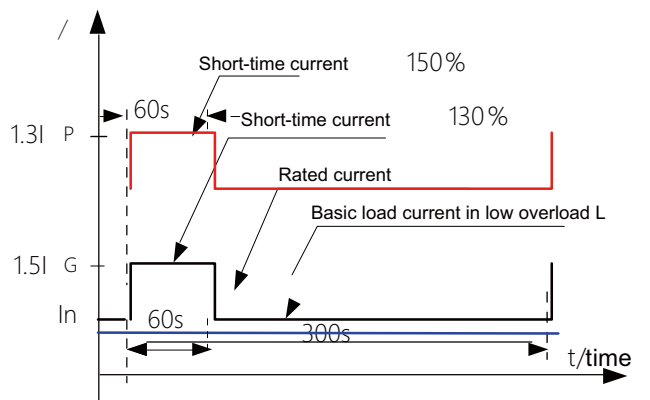

## Zero Impact Speed Tracking Start

A new generation of speed tracking start, which can achieve start with zero wait time and zero impact current.



## Faster and More Stable Tracking Effect

AC200 software processing time is up to 0.1s.

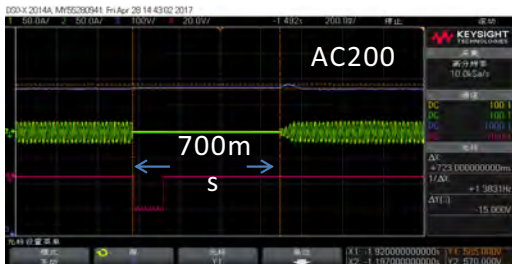

## Excellent Current Suppression and Bus Voltage Suppression

Current suppression function can avoid frequency inverter from frequent over-current alarm. When the current exceeds the current protection point, the over-current suppression function can continuously limit the current within the current protection point, thus protecting the safety of the equipment and avoiding over-current alarm caused by sudden load or interference.

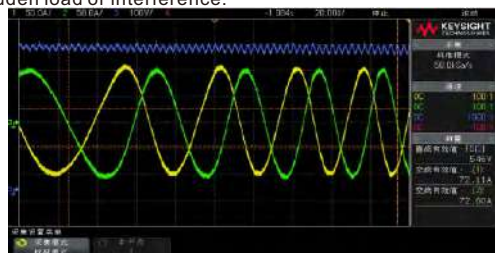

The over-voltage suppression function can prevent the frequency inverter from over-voltage alarm during acceleration / deceleration. When the frequency inverter bus voltage reaches or exceeds the over-voltage protection point during the acceleration or deceleration process, the over-voltage suppression function can automatically adjust the operating frequency to suppress the increase in bus voltage, thus protecting the safety of equipment and avoiding the frequency inverter from over-voltage alarm caused by bus voltage increase.

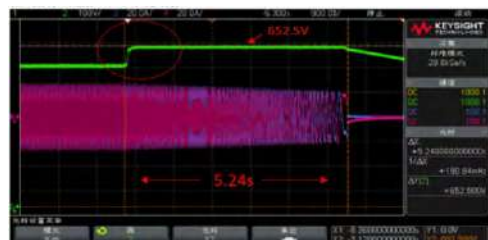

## Non-Stop Function During Instantaneous Power Failure

This function means that the frequency inverter will not stop when there is instant voltage sag. In the case of instantaneous power failure or sudden voltage sag, the frequency inverter can maintain itself run continuously within a short time as it can compensate the voltage reduction through the load feedback energy within the effective time.

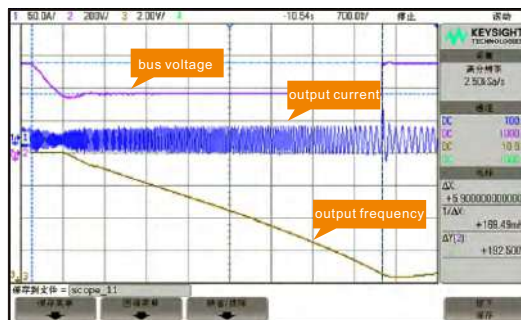

## Torque Limit and Speed Limit for Protecting Machines

AC200 will provide torque limit and speed limit protections. When the given torque or given speed exceeds the machine's maximum torque range, the inverter will output torque or frequency as the maximum value to protect equipment safety on premise of excavating machine's maximum efficiency.

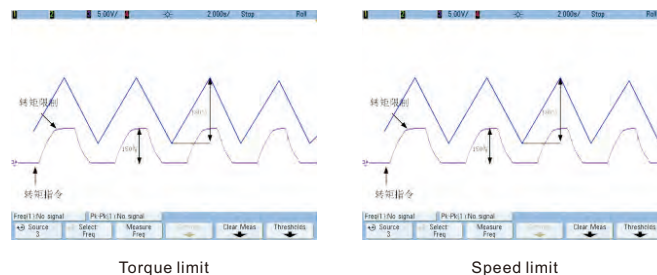

## Built-in Multi-group PID Function Module

Built-in two sets of PID parameter group; automatically switch according to the deviation, DI terminal conditions; Various given and feedback source selection, rich types, practical; PID feedback disconnection detection function, user-friendly fault diagnosis; PID control suspend detection function, user-friendly real-time monitoring; PID factory parameters preset, meeting the operating requirements of specific equipments; Adapted to the fan pumps, wire drawing machine, cable and other occasions of changeable diameters; Simplified the debugging process to facilitate equipment maintenance.

## Various Braking Methods and Fast Stop

Energy consumption brake	DC brake
Large braking torque, fast braking speed	Brake unit and braking resistor are not required
It is applicable for large inertia load frequent braking occasions	occasions that motor needs to brake firstly and then restart for free running, and applicable for the occasions which need to maintain torque output at zero speed.
The brake unit and the braking resistor must be configured	Not suitable for large inertia load frequent or fast braking; not applicable for braking when motor is running at high speed.

## Rich Application Functionality

Function	Effect
Pressure frequency separation	Output voltage and output frequency can be independently set and adjusted, generally used for EPS power supply, torque motor control, high frequency heating and other industries.
Current limiting	Through the hardware protection, it can limit the current rise to a certain extent, ensuring the normal operation of equipment, avoiding over-current fault and shutdown what affects production.
Switch delay Analog deviation value	It provides more flexible control modes, suitable for various on-site controls.
Speed tracking	Start the instantaneous detection to motor speed and direction. In the condition that motor is running with large inertia load, it ensures the motor starts at the current speed, to avoid the motor from reverse rotation.
Instantaneous power failure non-stop	When the voltage sag happens, it can maintain the equipment running continuously without shutdown in the effective time, ensuring the continuity of equipment operation.
Simple PLC	Frequency inverter can automatically switch the running direction and frequency according to the time set by the simple PLC, so as to meet the on-site process requirements.
Virtual I/O	The actual X / Y terminal wiring can be simulated by the internal virtual terminal, eliminating the actual terminal wiring, saving the actual number of terminals as well as reducing the external wiring.

## Flexible and Practical Function Terminals

Terminal type: 7 groups of input terminals, 3 output terminals, 3 analog inputs, 2 analog outputs, 1 pulse input.

Terminal function selection: 63 kinds of input terminal, 31 kinds of output terminal, 18 kinds of analog output.

Analog input terminals can be set up to three kinds of curves, two sets of inflection point corresponding relationships; AI terminal also supports voltage or current analog input.

Analog output terminals: supports both voltage and current analog outputs, AO2 terminals support up to 100KHz pulse output.

Note: Input terminal X7 supports digital input or pulse input.

## Communication Function

Support for fieldbus expansion, and can support the PROFIBUS protocol through the optional DP card.

Provide a variety of communication interfaces, and can achieve RS485, DP, CAN and CanOpen communication.

Expandable relay output, analog input and RS485 communication.

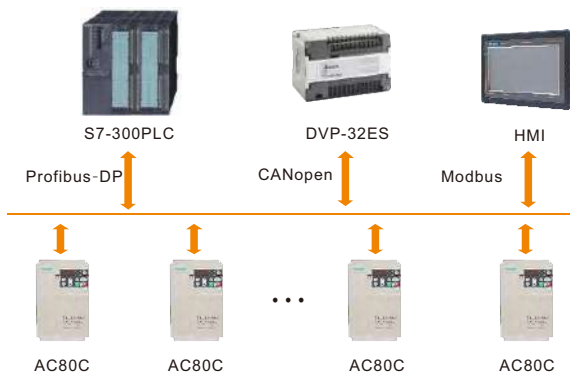

## Rich Extensive Features

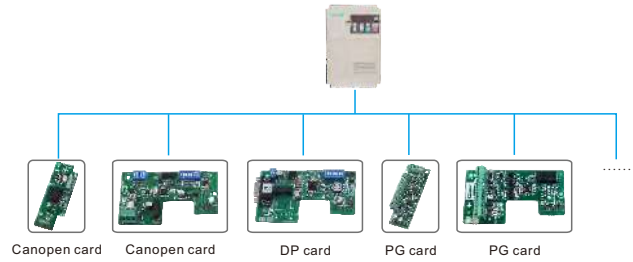

## VEICHI IOT

Intelligent terminal, high positioning accuracy, small and beautiful, easy to install;

Using GPRS and GSM dual-mode communication, stable operation, and reliable performance;

Through the remote monitoring module, it can achieve online-monitoring and remote fault diagnosis, providing customers with more value-added services.

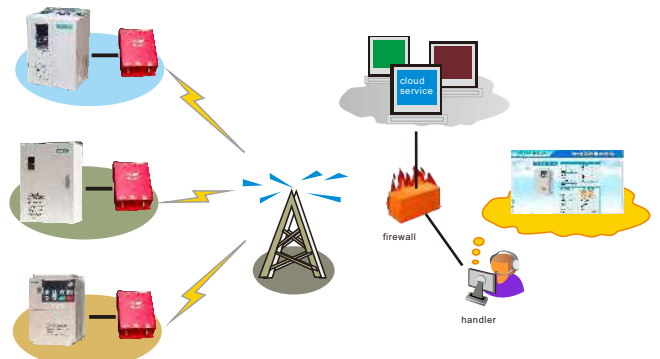

## Advantages of VEICHI IOT System

1. Anti-dismantle and capable of preventing mistaken lock.
2. Prevent overdue bills.
3. Double positioning.
4. Warm reminder.

## Powerful Background Software

Support parameter operation and virtual oscilloscope function of frequency inverter (can realize the graphics monitoring of frequency inverter inner status.)





# Application Areas

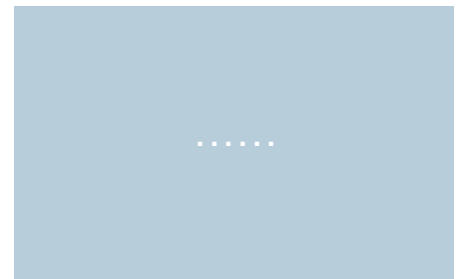

# Special Frequency Inverter Series

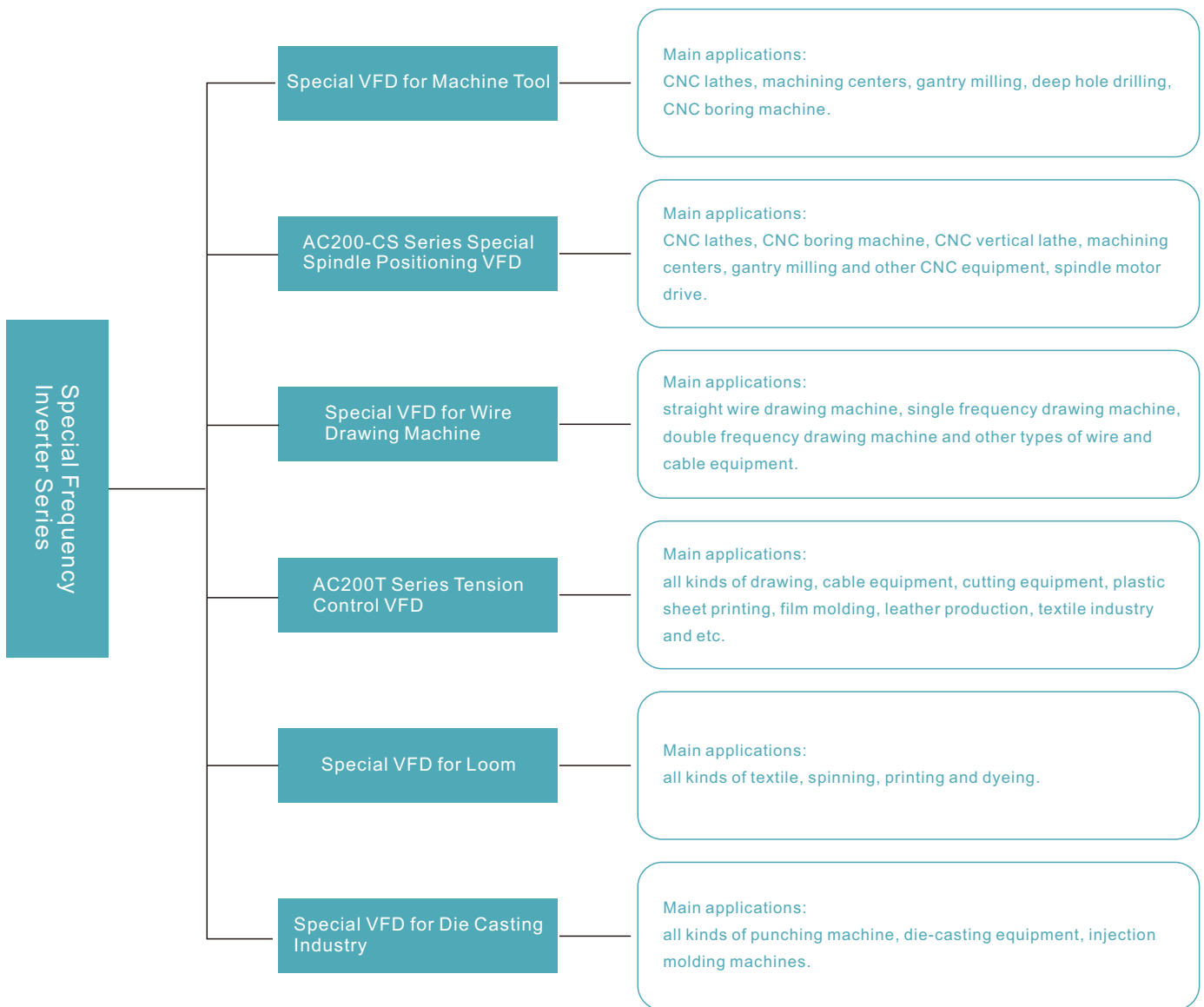



# Special VFD for Machine Tool

## Product overview

It is the latest high performance machine tool purpose vector control frequency inverter, adopting industry-leading magnetic flux algorithm and modular design to achieve high-performance and high-precision motor drive control. Combining with machine tool industry characteristics and high reliability, it can meet the processing demands of different products.

## Product Features

- ⊙ Machine tool motor dedicated macro parameters, simplified parameter settings.
- ⊙ Large torque output at low frequency, fast torque dynamic response speed.
- ⊙ Carrier smoothing function, effectively reducing motor noise.
- ⊙ High seismic design, suitable for machine body vibration.
- ⊙ Sealed design, thick three anti-paint treatment, easy to deal with a variety of harsh environments.



## Load Strain Capacity

- ⊙ Automatic current limit technology and automatic frequency adjusting technology can response to sudden load changes.
- ⊙ Avoid frequent drive from fault reports, ensure its fast response characteristics and high producing efficiency.

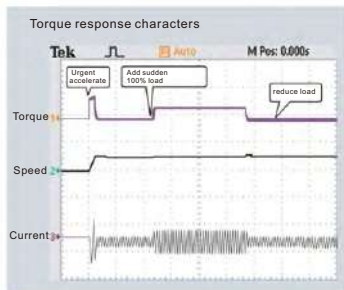

## Noise Control

Compared to sharp motor noise of fixed carrier, the output voltage harmonics spectrum of random carrier is evenly distributed over a wide frequency range, effectively reducing motor noise.



Random carrier off

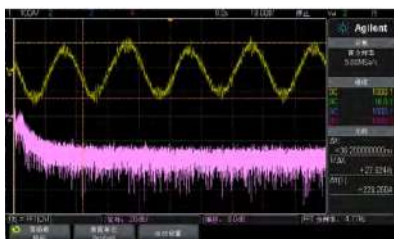

Random carrier on

## Large Torque at Low Frequency

- ⊙ In low frequency and weak magnetic field, torque performance is optimized.
- ⊙ It has linear torque feature in the whole speed range.
- ⊙ Torque dynamic response time is less than 20ms.

Blue part is ACS0C increased running range

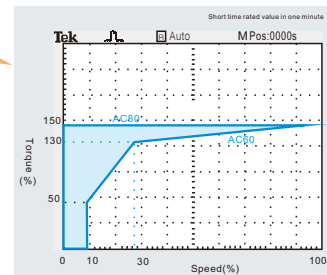

## Deceleration Over Excitation Function

According to the set deceleration over excitation current, the output current can be kept constant, which not only can quickly consume motor feedback energy to prevent over voltage of bus capacitor but also can produce large resistance torque to stop motor quickly and improve processing efficiency.

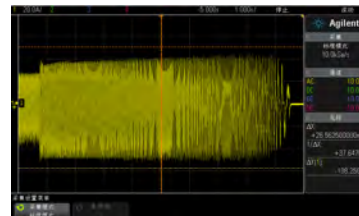

If deceleration over excitation is off, output current is small and deceleration time is long.

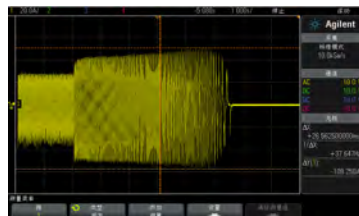

If deceleration over excitation is on, output current increases and deceleration time shortens.

# AC200-CS Series Special VFD for Spindle Positioning

## Product Description

AC200-CS spindle servo system is a high-end product specially developed for the machine tool industry by Veichi Electric, adopting brand-new software and hardware platform. Through the closed-loop servo control to motor, it can achieve high precision motor speed control and position control. As it can meet a great variety of control needs to spindle, so it has wide applications in the machine tool industry.



## Product Features

- ⊙ Speed range- 1: 5000, excellent torque at low frequency.
- ⊙ Steady speed accuracy  $\pm 1$ rpm, position accuracy  $\pm 1$ puls.
- ⊙ Can achieve spindle division, rigid tapping, thread cutting and other specific machine tool functions.

## Adaptable Motor

Spindle servo motor, electric spindle, ordinary three-phase asynchronous motor.



## Strong Rigidity at Low Frequency

At 0.5Hz, it can output 180% of the rated torque, ensuring that the machine tool has high reliability and stability during manufacturing workpiece at low speed. In the zero servo state and the condition of rated load, the fastest response can be completed within 50ms and it can also ensure that the spindle is always in the stopped state.

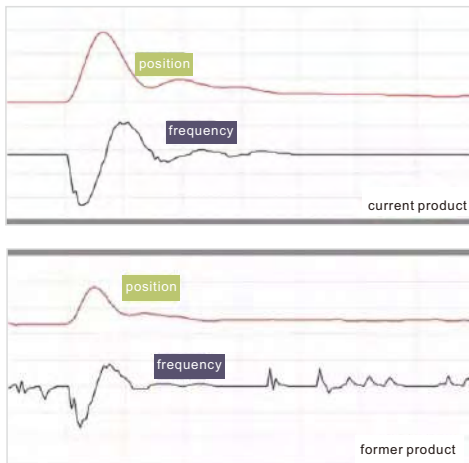

## Speed, Position Response Promotion

Combined voltage and current suppression with dynamic braking, AC200-CS spindle drive enables the machine tool driving unit (spindle) achieve fast and steady acceleration and deceleration so as to improve the production efficiency. In the position mode, the loop adjustment cycle has been greatly improved, which ensures that the spindle can quickly make a position response, and quickly complete the positioning control.

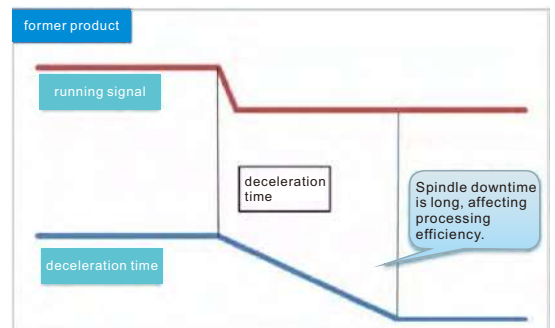
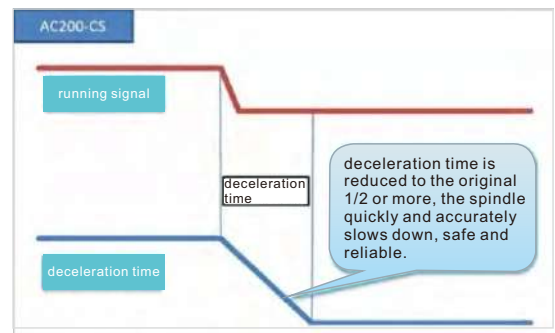

## Spindle Special Function

Speed control	0~12000RPM
Spindle indexing	Can achieve multi-position control via terminal or external pulse (up to 8 points for terminal)
Rigid tapping	Cooperate with feed shaft to achieve rigid tapping function, the error is 2%.
Other functions	Thread cutting, electronic gear, position and etc.

# Special VFD for Wire Drawing Machine

## Product Description

High-performance wire drawing machine frequency inverter is specially designed for wire drawing machine combined many years of experiences. It can achieve high precision speed control and torque control of the motor to meet the operation and control requirements of frequency inverter in wire drawing industry. With its excellent performance, this product has won the recognition and praise from the wire and cable enterprise and wire production enterprises.

## Product Features

- ⊙ Ultra low-frequency torque, fast dynamic response characteristics, ultra-stable speed accuracy.
- ⊙ Unique tension control algorithm, fast response to tension and instantly achieve stable state.
- ⊙ Resistance to metal powder, independent duct technology.
- ⊙ PCBs are all coated with thickened three anti-paint treatment.
- ⊙ High seismic design, easy to deal with cabinet vibration of drawing machine.
- ⊙ All the tension algorithms are integrated into the frequency inverter; meanwhile, the drawing machine features are integrated into the frequency inverter. Without external control circuit, it can achieve all the complex control of drawing machine, greatly simplifying the original equipment control circuit.
- ⊙ Tension control is completed by variable frequency, featuring high precision and stable performance. The frequency inverter integrates various special parameters of wire drawing machine, directly calls the corresponding system parameters that users do not need to set parameters one by one.

## Special Design According to Wire Drawing Machine Characteristics

### Easy Parameter Setting

As the frequency inverter has built-in multiple sets of wire drawing machine parameters, it can be directly set as water tank drawing machine host or slave that users do not need to set the parameters one by one. The default parameters are in full compliance with the equipment requirements, and users can debug it simply and quickly.

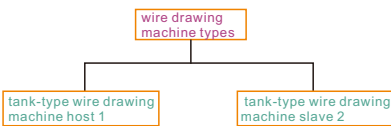

In the parameter settings, select 1 for the tank-type wire drawing machine host, select 2 for the tank-type wire drawing machine slave. After selection, it will display the default parameters, no need to set again.

### Adopting Vector Control in Full Power Section, Perfect Current Control

Relying on years of technology accumulation, Veichi Electric has a very mature current vector control technology. In the low voltage, it can also start normally with load. The significance of vector is decoupling the stator current into the excitation



current and torque current through the coordinate transformation, so that we can independently adjust the two components so as to easily adjust the load for enhancing the motor output effect at low frequency.

## Stable Tension Control

Tension is calculated by the rolling diameter and tension PID; winding inverter calculates the rolling diameter in real time according to the feedforward signal and the current winding frequency, and corrects the speed ratio between the host and the slave through the rolling diameter so as to reduce the amount of PID adjustment and make the system more stable.

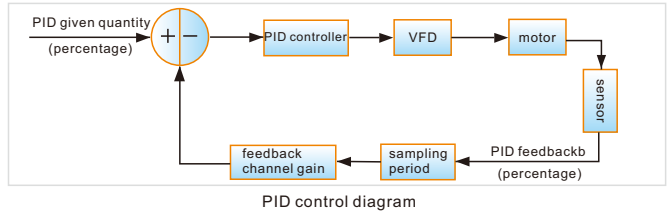

## Complete Functions

The system has integrated all the functions of the wire drawing machine into the frequency inverter. Without the external controller or PLC, we can complete the control function.

- Simple system: the frequency inverter of simple circuit can achieve all the control requirements of wire drawing machine, no external controller required.
- Smooth start: start logic control and rolling diameter calculation function, ensuring that it can start smoothly at any rolling diameter.
- Stable control: four sets of PID parameters can ensure that the whole pendulum control effect is stable.
- Wire break detection: it can be set to determine automatically by software or external input disconnection signal flexibly, to ensure system stability.

## Schematic Diagram of Wire Drawing Machine Winding and Unwinding

Wire & cable winding and unwinding is as shown in diagram (a) (b): generally it is composed of host, stretch film, tension balance bar, wire winding machine, traverse machine and etc.

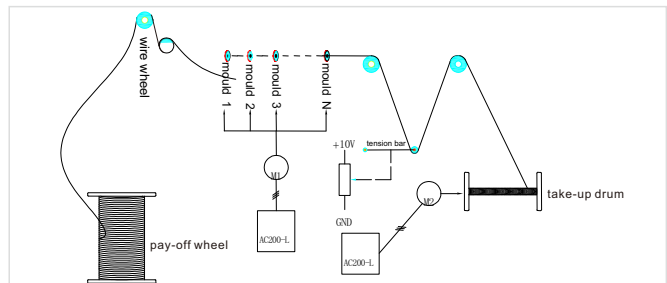

(a) Wire drawing machine variable frequency control diagram of passive pay-off and constant tension take-up

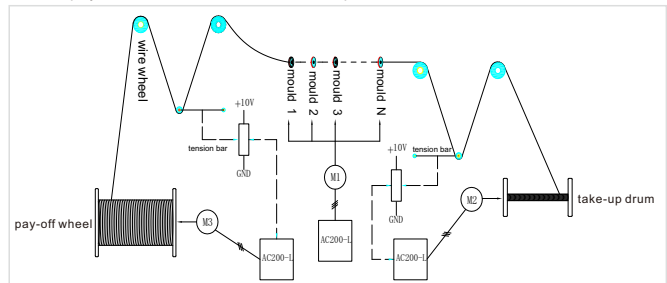

(b) Wire drawing machine variable frequency control diagram of active pay-off and constant tension take-up

## Electronic Control Solution for Wire Drawing Machine Industry

- System solution for dual frequency conversion wire drawing machine
- System solution for no pendulum dual frequency conversion wire drawing machine
- System solution for diameter wire drawing machine
- System solution for dynamic pay-off stand
- System solution for automatic pay-off drum
- System solution for cantilever single strand

# AC200T Series - Tension Control Frequency Inverter

## Product Description

AC200T special tension control frequency inverter keeps the constant tension through the output torque control and the automatic rolling diameter calculation. With no need of install tension sensor, without current position feedback or the external signal of tension, even without installing the rotary encoder which is used for speed feedback, AC200T can complete the tension control in most application cases. During the control of winding and unwinding, it can accurately provide tension, ensuring that the processed material thickness is uniform. It has string adaptability to rolling diameter of winding and unwinding. It starts smoothly and is capable of achieving tension control at both high speed and low speed. It adopts advanced torque identification algorithm, which can automatically compensate for the moment of inertia and static and sliding friction so as to fundamentally ensure consistent tension control during material processing. It adopts intelligent diameter identification which is of high accuracy and anti-disturbance ability.

## Professional Treatment for Tension Control

When the torque is constant, the tension is inversely proportional to the rolling diameter; therefore, we need to change the torque according to the rolling diameter during winding and unwinding process, in order to maintain a certain tension value.

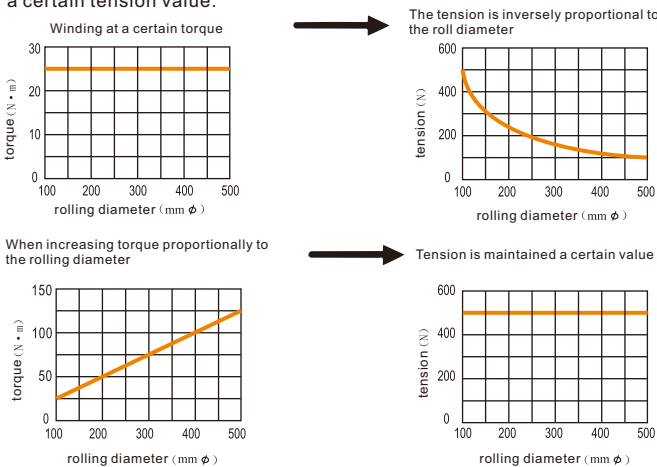

## Rolling Diameter Calculation Method

During tension open-loop control, the calculation of rolling diameter is a very important part. Frequency inverter has 2 kinds of rolling diameter calculation methods.

### Line Speed Method

$$v = \kappa \times \omega \times r$$

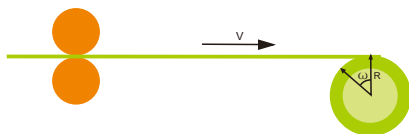

AC200T tension control frequency inverter can obtain accurate winding diameter according to the line speed, own angular velocity, mechanical reduction ratio. In the formula,  $v$  represents the linear velocity of the drawing side,  $\omega$  represents the angular velocity of the motor rotation (calculated by the frequency converter),  $\kappa$  represents the mechanical reduction ratio,  $r$  (required for tension winding) represents the winding diameter.

## Thickness Integral Method

The rolling diameter is accumulated according to the rotating circles of winding drum and material thickness, thereby obtaining the material roll diameter.

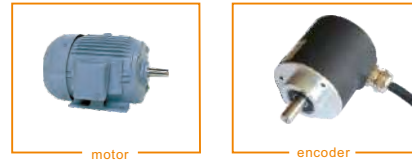

AC200T tension control frequency inverter accumulates the winding axis rotation cycles through the encoder, proximity switch and other components, thereby getting the winding diameter. No need to add external proximity switches and circle-counting devices.

## Fast Response Under Low Torque

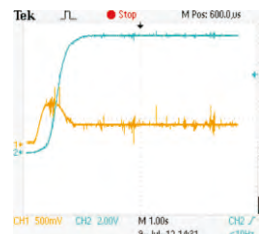

The green line represents the motor speed, 10V corresponds to 1500rpm. The yellow line represents the output torque, 10V corresponds to 200% of the rated torque.

## Smooth Operation



Compared with AC90, AC200 has reduced the torque pulsation without PG card, capable of achieving more stable operation.

## Automatic Roll Change

Tension control frequency inverter has rich automatic roll change function that it can achieve high-speed non-stop automatic roll change, greatly improving the production efficiency.

## Friction Compensation

Special tension control frequency inverter is specially designed with compensation according to the dynamic and static friction of mechanical system, which can optimize the tension control effect and improve the tension system stability and response speed.

## Taper Coefficient

Special tension control frequency inverter is specially designed for occasions which the tension decreases when the rolling diameter increases; by setting the taper coefficient, it can achieve the formation of winding so as to get better molding effect.

## Electrical System Solution

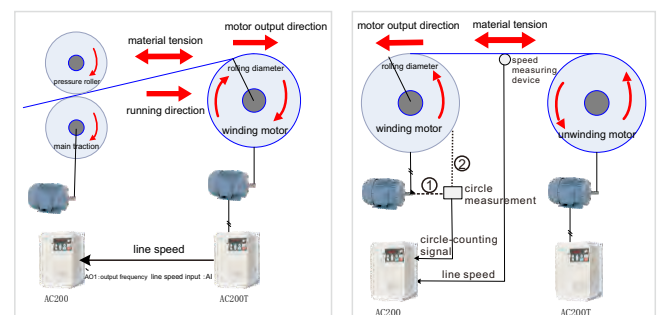



# Special VFD for Loom

## Product Description

The spindle motor of traditional jet weaving industry adjusts the speed in the way of pulley replacement, and its starting is of triangular starlike mode. This control mode has many shortcomings such as low efficiency, high labor costs, maintenance difficulty, easy to damage and etc. After variable frequency transformation to spindle motor by VEICHI products, now you can achieve stepless speed regulation, and the frequency inverter has been added super-start function that the start response time can fully meet the high-precision requirements of this industry. The warp unwinding and cloth forming winding can be perfectly controlled. We can provide customers with customized jet weaving system solutions.



## Product Features

### High Performance

- ◎ V/F, high precision speed output without PG vector control, small torque pulsation.
- ◎ Provide rich interface resources, and 485, CAN bus communication.
- ◎ Special super-start function for jet weaving industry, start-up time up to 70ms.
- ◎ In the static load status, it can accurately identify all the parameters of motor.

### Delicate Structure

- ◎ Divide according to customer needs: independent cabinet machine, penetrating-type installation for cabinet machine
- ◎ No fan design and radiator passivation design for jet weaving industry.
- ◎ One molding in seal strangulation for cabinet door, seamless connection.
- ◎ Protection degree IP54



### Smooth Running

Suppress the vibration during the running process through the vibration suppression algorithm, in order to improve the anti-interference capability of system.

Achieved the stepless speed adjustment of loom, greatly improved the efficiency of the water jet loom, and solved the damage to the equipment during the mechanical belt replacement.

## Rich Expansion Functionality



### Profibus-DP card

VEICHI Profibus DP fieldbus is widely used for its high speed and low cost advantages in communication between device level control system and distributed I/O.



### External Expansion PG Card Module

PG card is mainly used in vector-type frequency inverter for detecting and feedback motor speed and direction signal, so the motor speed and torque can be controlled precisely.



### GPRS Wireless Module

Multi-machine remote communication controls the equipment operation status. Remote diagnostic service

## Jet Weaving Electrical System Solutions

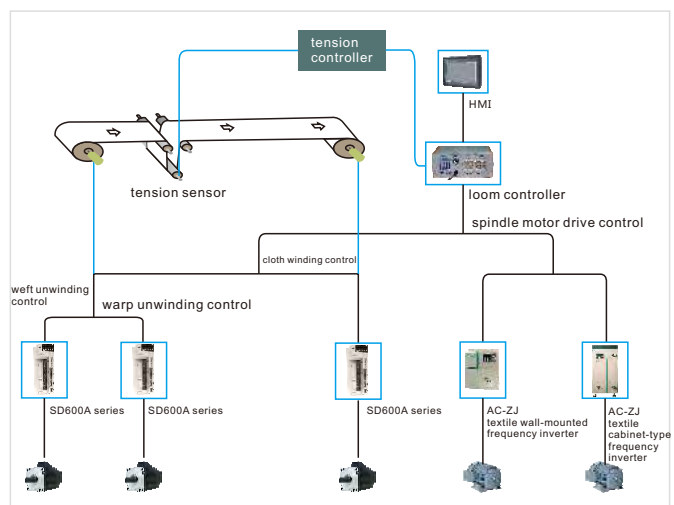

# Special VFD for Die Casting Industry

## Product Description

Forging industry purpose frequency inverter is a high performance vector control inverter which is specially developed according to the punching machine characteristics. This product adopts the latest generation of high-speed motor control dedicated DSP (TI's TMS320F28062) that its computing speed has been increased by 50% and the program capacity has been doubled. It adopts the international leading vector control algorithm to achieve high-performance and high-precision motor control. While improving the product reliability and environmental adaptability, we also enhanced the ease of use and industry-specific design so that the product is more feature-rich with flexible applications and stable working performance. Meanwhile, it features richer interface sources and stronger expansion capability supporting multiple communication interfaces.

## Product Features

- ⊙ It can be matched with the level of motor, no need to increase a gear.
- ⊙ Strong anti-interference ability; random carrier function can deal with motor noise easily.
- ⊙ Unique voltage suppression function can easily inhibit the DC side bus voltage.
- ⊙ Unique current suppression function, the by-wave current limiting function which is newly added into the hardware can quickly suppress the load current.
- ⊙ Vector control, high speed accuracy, wide speed range, large torque at low frequency, strong overload capacity.
- ⊙ Compact, built-in DC reactor, the volume size is further reduced because of design optimization.
- ⊙ High reliability, the whole seismic design, wide voltage input, three anti-paint automatic spraying process.

## Professional Treatment for Punch Features

### Fast Deceleration Stop

Significantly reduce the braking distance when motor shuts down, the motor speed is slow when the frequency inverter stops.

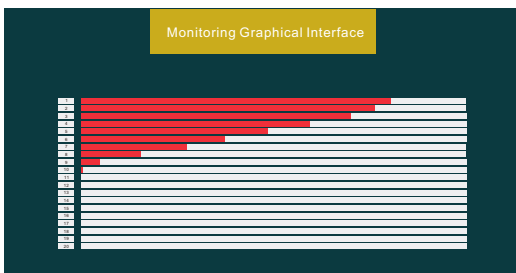

The deceleration distance during forward running and reverse running

### Speed Tracking Function

Speed tracking function of greater tracking frequency range, the minimum tracking speed is 1.00Hz, so the tracking speed is faster.

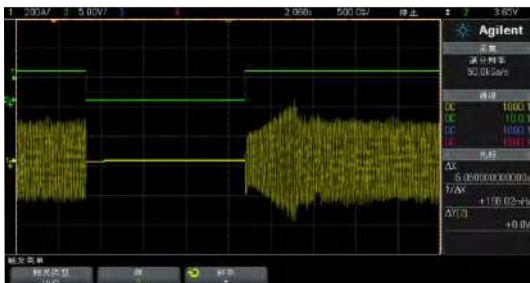

## Unique Voltage Suppression Function (no braking resistor installed)

- ⊙ Overvoltage suppression function: when the bus voltage is detected to rise, it will increase the output frequency to set the motor in the electric state.
- ⊙ Over-excitation function: no need to increase the external brake resistor and other accessories, to achieve rapid braking effect, improve product ease of use; more effectively inhibit the bus voltage rise during the deceleration process to avoid frequent over-voltage failure, meanwhile achieve fast braking and fast stop when power failure happens.

It can automatically and quickly suppress the frequency inverter voltage during the deceleration, constant speed and stopping process in order to prevent over-voltage failure so that the equipment can work stably.

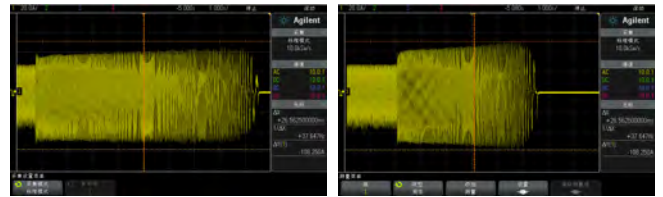

Overexcitation brake function is invalid Overexcitation brake function is valid

## Unique Current Suppression Function

- ⊙ The platform is a high-performance vector frequency inverter which controls the current perfectly through the mature current vector technology.
- ⊙ The current increases and the motor speed decreases when the motor load increases suddenly or the motor is in stepping move state, especially when the punch press performs deep drawing. At this time, the instantaneous slip of the motor is widened (that it is to say, the speed is instantly slowed down), which can quickly reduce the frequency to ensure that the motor speed and output frequency corresponds to each other (ensuring the slip frequency is small); as the slip frequency is proportional to the current, so it can ensure that the current of the inverter will not increase too much and report the overcurrent fault.
- ⊙ Through by-wave current limiting to hardware, it can rapidly suppress the current increase to ensure the output current is maintained within the hardware-limited range and avoid frequent overcurrent failure.

Through the targeted treatment in software, it can effectively prevent the inverter over current, so that the equipment can work normally without alarm.

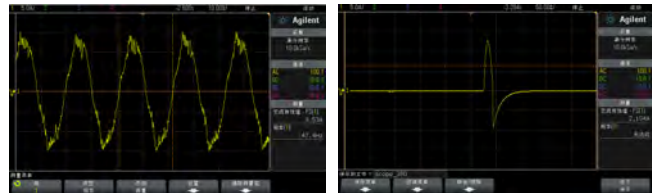

Turn on by-wave current limiting function Turn off by-wave current limiting function

## Current Oscillation Suppression

Current oscillation suppression: through the feedback of the excitation current component, it adjusts the vector angle of the output voltage so as to ensure the output current stability.

## Anti-Interference Treatment

Ao2 adopts differential signal output which can completely solve the signal interference problem during transmission process. When the transmission distance is greater than 5m, the transmission mode of collector open signal is unstable.



# AC Series – Standard Vector Frequency Inverter

## AC\*\* - T 3 - 011 G / 015 P

Frequency Inverter Series  
 AC70 series  
 AC70E series  
 AC200 series

Voltage Class  
 T : Three phase  
 S : Single phase

Voltage Class  
 2 : 220V  
 3 : 380V  
 6 : 660V  
 11:1140V

Frequency Inverter Type

G : General type  
 P : Fan and pump type  
 Z : Special type for plastic machinery  
 L : Special type for wire drawing machine  
 H : Medium-frequency type  
 GD : Cabinet machine with base  
 PD : Cabinet machine with base

Adaptable motor power (KW)

7R5 : 7.5  
 011 : 11  
 015 : 15  
 018 : 18.5  
 022 : 22  
 030 : 30

## AC70E Series Wiring Diagram

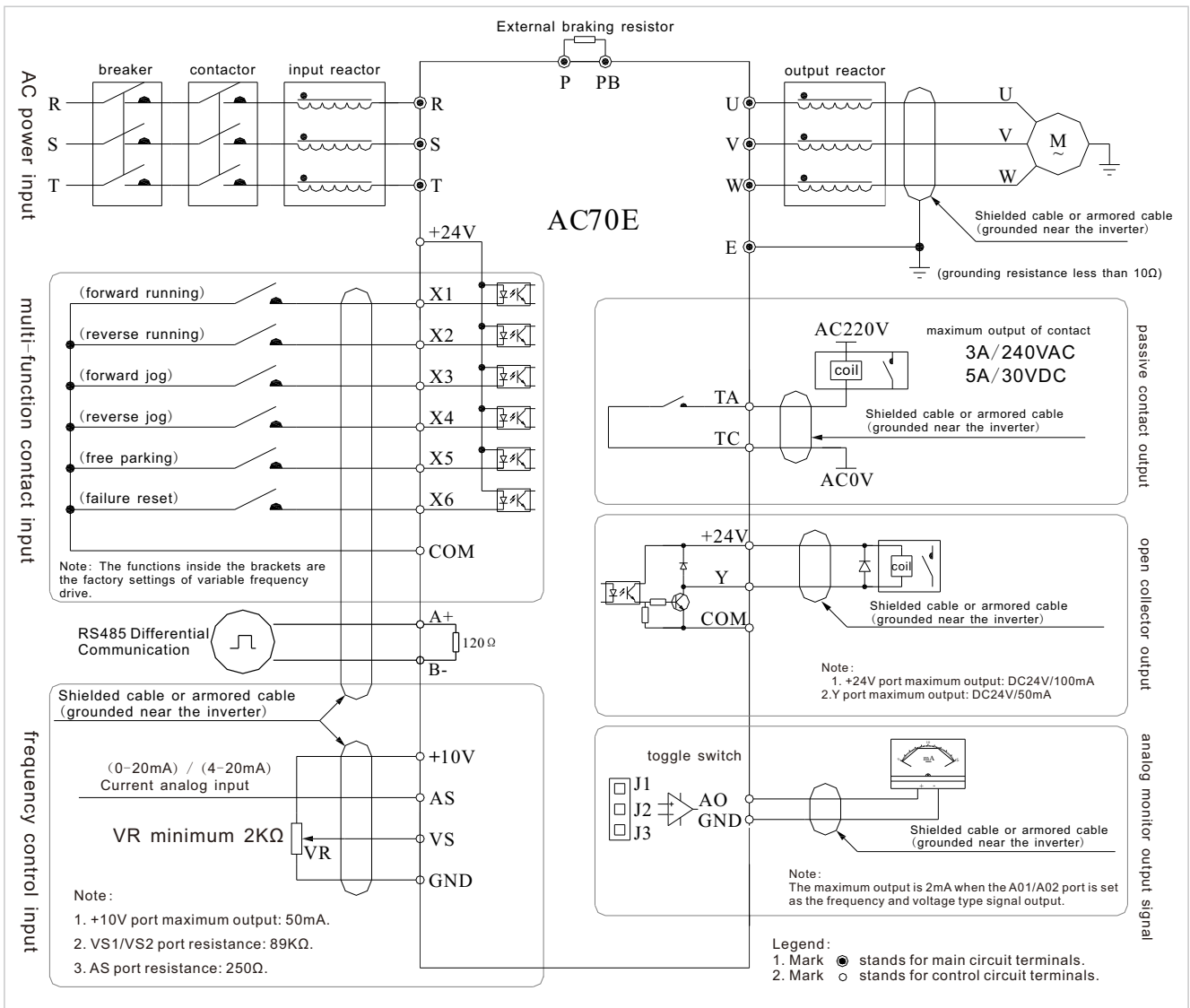

# AC70 Series Wiring Diagram

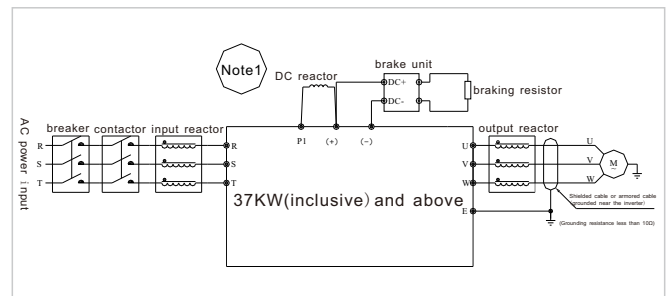
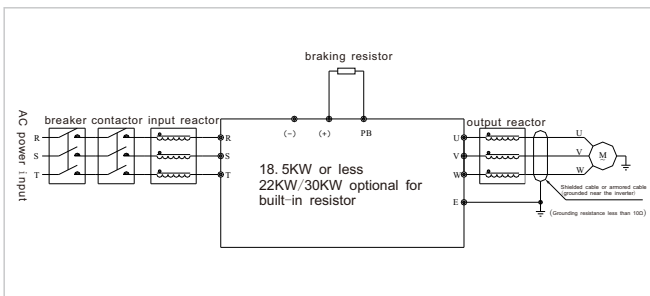
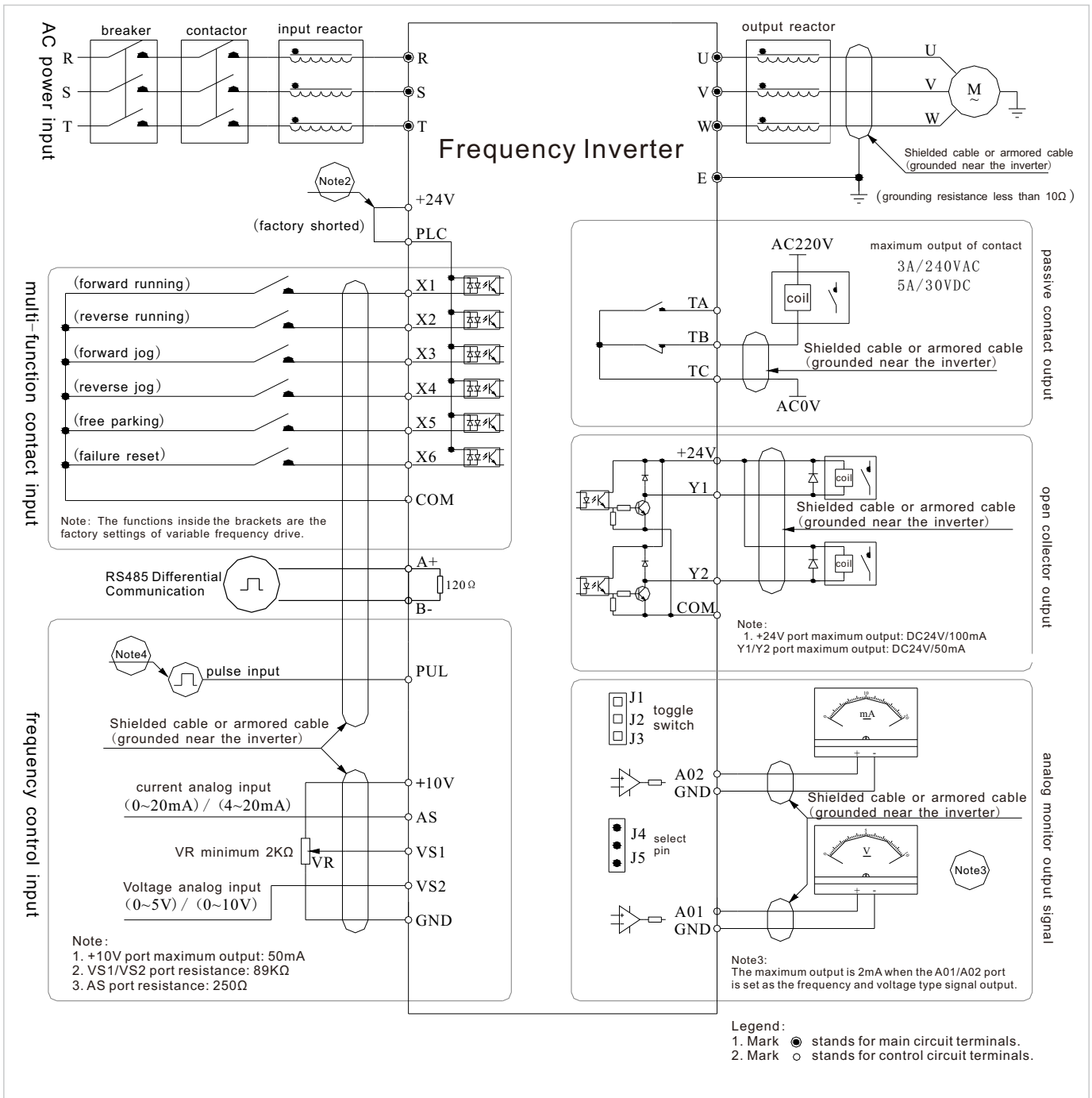

# AC200 Series Wiring Diagram

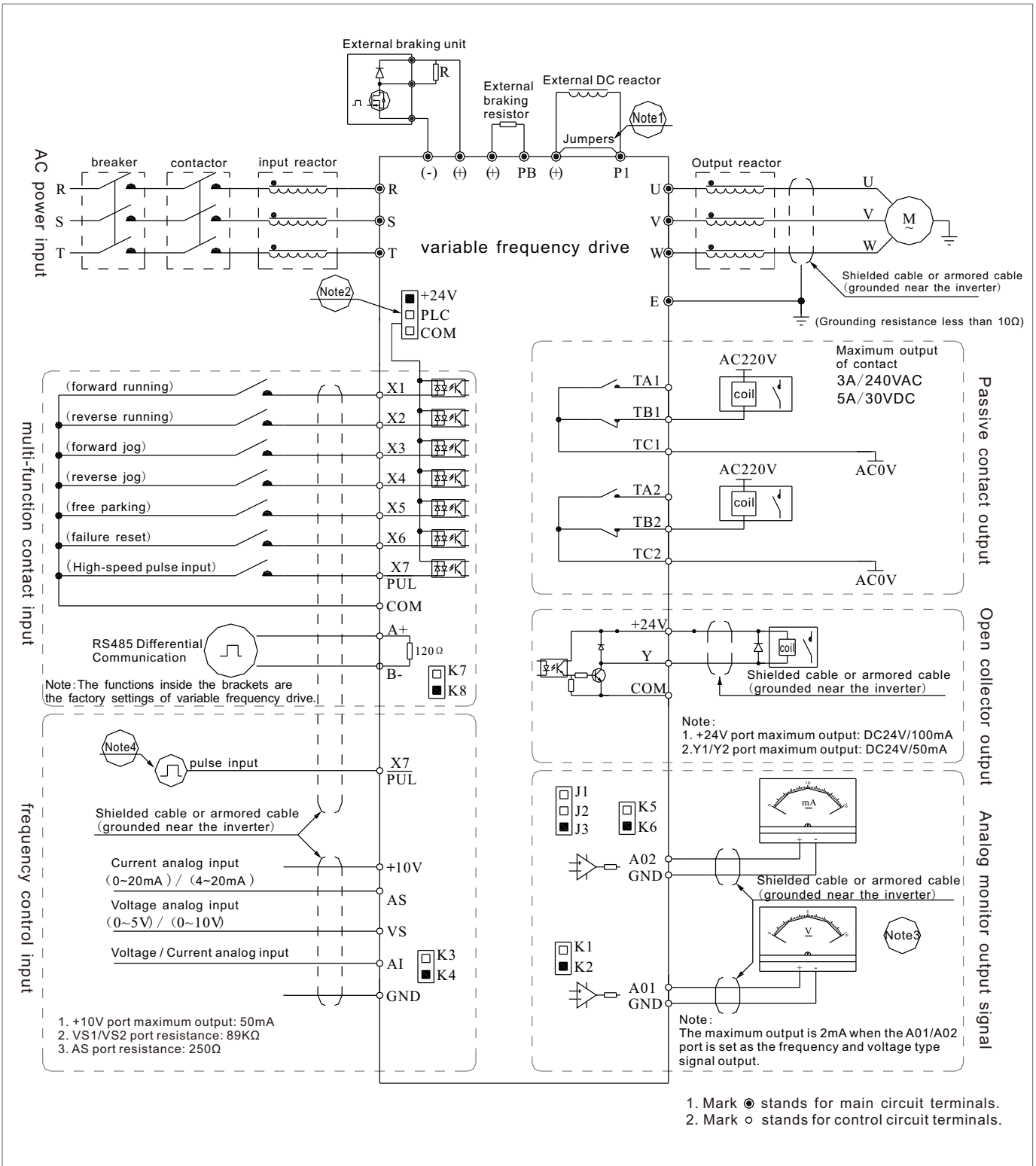

## Parameter Table

Voltage level	Serial number	Models	Input current	Output current	Adaptive motor	Product series	Exterior structure	
Single phase 220V 50/60Hz	1	S2-R75G	8.2A	4A	0.75KW	AC70E	A-1	
						AC70	B-1	
						AC200		
	2	S2-1R5G	14A	7A	1.5KW	AC70E	A-1	
						AC70	B-1	
						AC200		
	3	S2-2R2G	24A	10A	2.2KW	AC70E	A-2	
						AC70	B-2	
						AC200		
	4	S2-004G	38A	16A	4KW	AC70	B-3	
						AC200		
	5	S2-5R5G	44A	20A	5.5KW	AC70	B-3	
						AC200		
	6	S2-7R5G	67A	30A	7.5KW	AC70	C-1	
						AC200		
	7	S2-011G	92A	42A	11KW	AC70	C-2	
						AC200		
	8	S2-015G	129A	55A	15KW	AC70	C-2	
						AC200		
	Single phase 220V 50/60Hz	1	T2-R75G	6.5A	4A	0.75KW	AC70	A-1
							AC200	B-1
		2	T2-1R5G	9.2A	7A	1.5KW	AC70E	A-1
							AC70	B-1
		3	T2-2R2G	11A	10A	2.2KW	AC200	
AC70E								
4		T2-004G	19A	16A	4KW	AC70	A-2	
						AC200		
5		T2-5R5G	23A	20A	5.5KW	AC70	B-3	
						AC200		
6		T2-7R5G	36A	30A	7.5KW	AC70	C-1	
						AC200		
7		T2-011G	44A	42A	11KW	AC70	C-2	
						AC200		
8		T2-015G	60A	55A	15KW	AC70	C-2	
						AC200		
Three phase 380V 50/60Hz		1	T3-R75G	3.4A	2.3A	0.75KW	AC70	B-1
							AC200	
		2	T3-1R5G	4.9A	3.7A	1.5KW	AC70	B-1
							AC200	
		3	T3-2R2G	5.7A	5.0A	2.2KW	AC70	B-1
							AC200	
		4	T3-004G	12A	10A	4KW	AC70	B-2
							AC200	
	5	T3-5R5G	15A	13A	5.5KW	AC70	B-2	
						AC200		
	6	T3-7R5G	21A	17A	7.5KW	AC70	B-3	
						AC200		
	7	T3-011G	26A	25A	11KW	AC70	B-3	
						AC200		
	8	T3-015G	35A	32A	15KW	AC70	C-1	
						AC200		

Voltage level	Serial number	Models	Input current	Output current	Adaptive motor	Product series	Exterior structure
Three phase 380V 50/60Hz	9	T3-018G	40A	38A	18KW	AC70	C-1
						AC200	
	10	T3-022G	47A	45A	22KW	AC70	C-2
						AC200	
	11	T3-030G	62A	60A	30KW	AC70	C-2
						AC200	
	12	T3-037G	76A	75A	37KW	AC70	C-3
						AC200	
	13	T3-045G	91A	90A	45KW	AC70	C-3
						AC200	
	14	T3-055G	111A	110A	55KW	AC70	C-3
						AC200	
	15	T3-075G	157A	150A	75KW	AC70	C-4
						AC200	
	16	T3-093G	184A	180A	93KW	AC70	C-4
						AC200	
	17	T3-110G	214A	210A	110KW	AC70	C-4
						AC200	
	18	T3-132G	253A	250A	132KW	AC70	D-1
						AC200	
	19	T3-160G	285A	310A	160KW	AC70	D-2/E-1
						AC200	
	20	T3-185G	317A	340A	185KW	AC70	D-2/E-1
						AC200	
	21	T3-200G	354A	380A	200KW	AC70	D-2/E-1
						AC200	
	22	T3-220G	388.9A	415A	220KW	AC70	D-3/E-2
						AC200	
	23	T3-250G	441A	470A	250KW	AC70	D-3/E-2
						AC200	
	24	T3-280G	479.6A	510A	280KW	AC70	D-3/E-2
						AC200	
25	T3-315G	580.7A	600A	315KW	AC70	D-4/E-3	
					AC200		
26	T3-355G	643.2A	670A	355KW	AC70	D-4/E-3	
					AC200		
27	T3-400G	723.1A	750A	400KW	AC70	D-4/E-3	
					AC200		
28	T3-450G	780.4A	810A	450KW	AC70	F-1	
					AC200		
29	T3-500G	835A	860A	500KW	AC70	F-1	
					AC200		
30	T3-560G	958.7A	990A	560KW	AC70	F-1	
					AC200		
31	T3-630G	1050A	1100A	630KW	AC70	G-1	
					AC200		
32	T3-700G	1202.7A	1260A	700KW	AC70	G-1	
					AC200		

# Mounting Dimensions

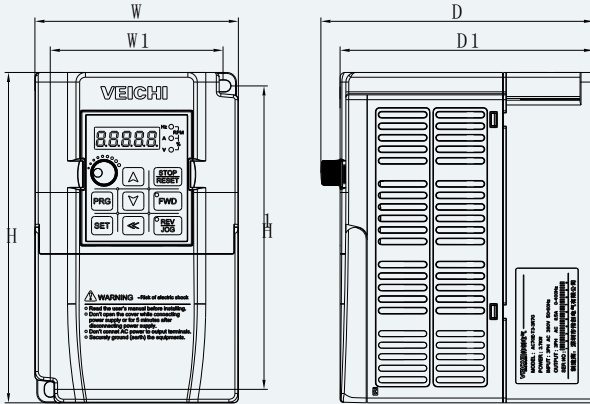

Size model	W	W1	H	H1	D	D1	Mounting hole
A1	88	75	142.5	129.5	142	132	φ5
A2	106	90	172	158	142	132	φ6

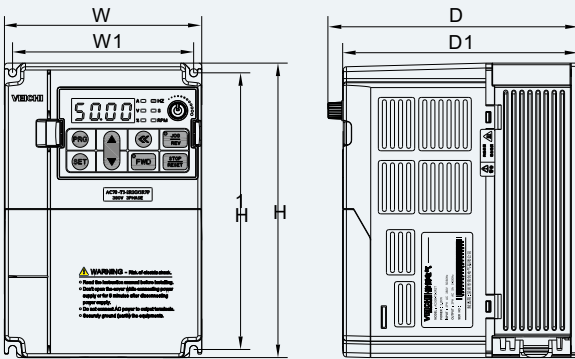

Inverter model	Dimensions				Mounting holes		Mounting hole
	W	H	D	D1	W1	H1	
B-1	122	182	154.5	145	112	171	φ5
B-2	159	246	157.5	148	147.2	236	φ5.5
B-3	195	291	167.5	158	179	275	φ7

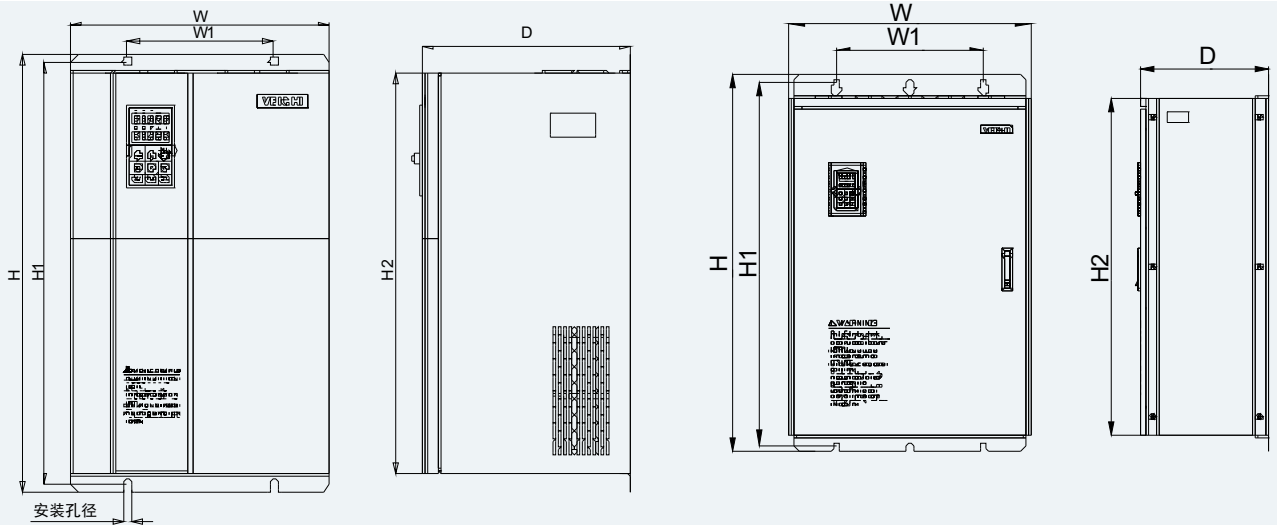

Inverter model	Dimensions				Mounting holes		Mounting hole
	W	H	D	D1	W1	H1	
C-1	235	345	200	311	160	331.5	φ7
C-2	255	410	225	370	180	395	φ7
C-3	305	570	260	522	180	550	φ9
C-4	380	620	290	564	240	595	φ11

## Wall-mounted mounting dimensions

Inverter model	Dimensions				Mounting holes		Mounting hole
	W	H	D	D1	W1	H1	
D-1	500	780	340	708	350	755	φ11
D-2	650	1060	400	950	400	1023	φ16
D-3	750	1170	400	1050	460	1128	φ18
D-4	850	1280	450	1150	550	1236	φ20



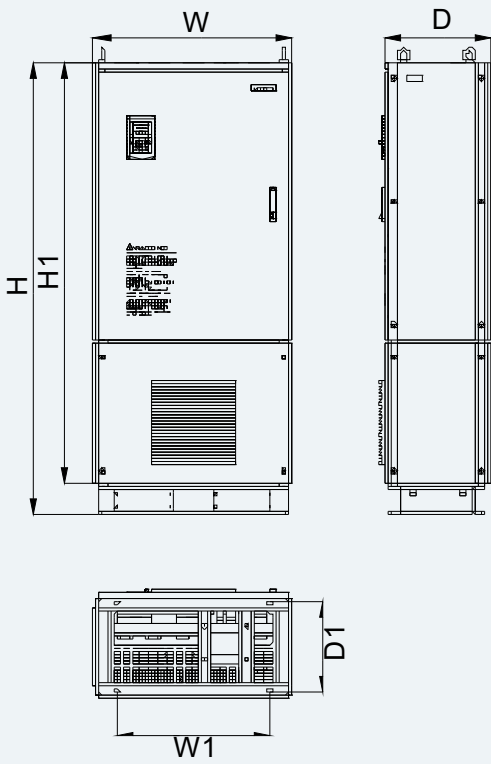

Cabinet mounting dimensions

Inverter model	Dimensions				Mounting holes		Mounting hole
	W	H	D	H1	W1	D1	
E-1	650	1600	400	1500	492	332	φ14
E-2	750	1700	400	1600	582	332	φ14
E-3	850	1800	450	1700	622	382	φ14

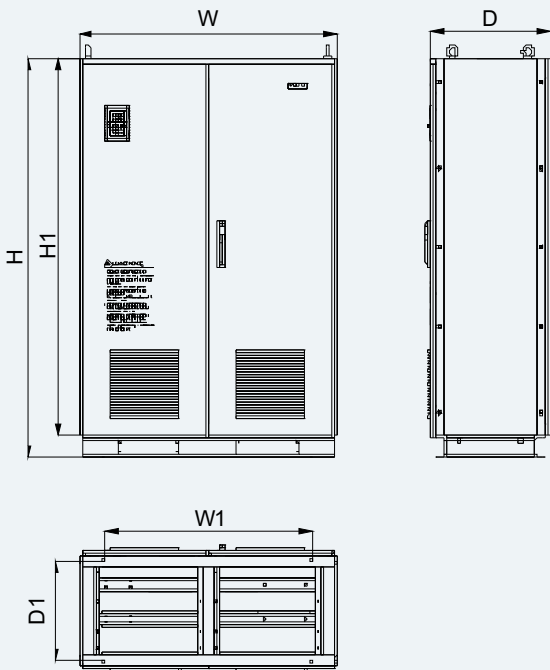

Inverter model	Dimensions				Mounting holes		Mounting hole
	W	H	D	H1	W1	D1	
F-1	1200	1850	550	1750	960	466	φ14

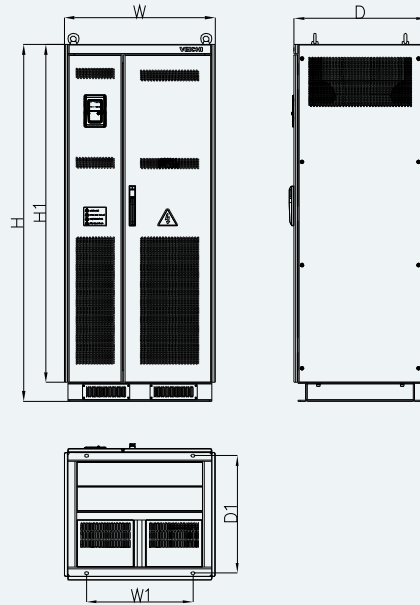

Inverter model	Dimensions				Mounting holes		Mounting hole
	W	H	D	H1	W1	D1	
G-1	800	1900	700	1800	564	626	φ14



### PG01-ABZ-05-C2

Feedback expansion card required when AC80C is performing close loop vector control or close loop V/F control. When PG feedback sensor is photoelectric encoder, select the card as PG feedback. Provide external DC12 / 5V encoder power supply, A, B, Z phase 3 differential inputs, compatible with 3-way open collector input and 3-way push-pull input signals, while supporting arbitrarily assigned output, the output signal is differential push-pull 3-way open collector output.

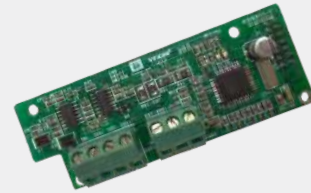

### Resolver PG Card

Resolver output signal is two-phase quadrature analog signal. And the amplitude would do cosine change as angle changes while the frequency and excitation frequency are consistent. When PG feeds transformer, select the card to do PG feedback. External encoder provides excitation source output, cos and sin signals input.



### CAN01 Card

Support CANOPEN protocol and CAN owned protocol.



### CAN-RS485 Card

It supports CANOPEN protocol and can be used to transfer MODBUS protocol.



### EX-PG02EN-A1.0

When arranged on AC80C, it is used to supplement the first PG card. When PG feedback sensor is photoelectric encoder, select the card as PG feedback. Provide external DC12 / 5V encoder power supply, A, B, Z phase 3 differential inputs, compatible with 3-way open collector input and 3-way push-pull input signals. Extended 3 X terminals, X8X9X10, provide external 24V power supply.

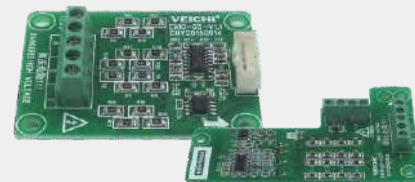

### EXIO-05-A1.1 Card

Sequence detection of frequency inverter R, S, T input (iron clad machine and integrated air compressor)

### EXIO-05-A2.0 Card

Sequence detection of frequency inverter R, S, T input (plastic cases machine, exclude 2.2KW)



### LCD Keyboard

AC70 series, AC80C series and AC200 series use LCD keypad. Supporting Chinese and English bilingual display and parameter copy function, you can upload and download parameters via the keyboard.



### Keyboard Extension Cable

2, 3, 5, 10, 15, 20-meter extension cable for connecting the keyboard and inverter control board quality inspection.

## Input Reactor

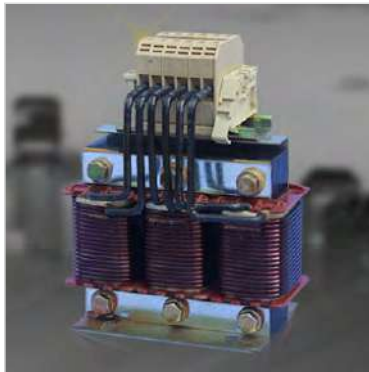

Model	AC input reactor	AC output reactor	DC reactor
R75G/1R5P	HKSG <sub>2</sub> -00075/G3	---	---
1R5G/2R2P	HKSG <sub>2</sub> -0015/G3	---	---
2R2G/004P	HKSG <sub>2</sub> -0022/G3	---	---
004G/5R5P	HKSG <sub>2</sub> -0037/G3	CKSG2-0040/G3	---
5R5G/7R5P	HKSG <sub>2</sub> -0055/G3	CKSG2-0055/G3	---
7R5G/011P	HKSG <sub>2</sub> -0075/G3	CKSG2-0075/G3	---
011G/015P	HKSG <sub>2</sub> -0110/G3	CKSG2-0110/G3	---
015G/018P	HKSG <sub>2</sub> -0150/G3	CKSG2-0150/G3	---
018G/022P	HKSG <sub>2</sub> -0185/G3	CKSG2-0185/G3	---
022G/030P	HKSG <sub>2</sub> -0220/G3	CKSG2-0220/G3	---
030G/037P	HKSG <sub>2</sub> -0300/G3	CKSG2-0300/G3	---
037G/045P	HKSG <sub>2</sub> -0370/G3	CKSG2-0370/G3	DCL0370-G3
045G/055P	HKSG <sub>2</sub> -0450/G3	CKSG2-0450/G3	DCL0450-G3
055G/075P	HKSG <sub>2</sub> -0550/G3	CKSG2-0550/G3	DCL0550-G3
075G/093P	HKSG <sub>2</sub> -0750/G3	CKSG2-0750/G3	DCL0750-G3
093G/110P	HKSG <sub>2</sub> -0900/G3	CKSG2-0900/G3	DCL0900-G3
110G/132P	HKSG <sub>2</sub> -1100/G3	CKSG2-1100/G3	DCL1100-G3
132G/160P	HKSG <sub>2</sub> -1320/G3	CKSG2-1320/G3	DCL1320-G3
160G/185P	HKSG <sub>2</sub> -1600/G3	CKSG2-1600/G3	Overall standard configuration
185G/200P	HKSG <sub>2</sub> -1870/G3	CKSG2-1870/G3	Overall standard configuration
200G/220P	HKSG <sub>2</sub> -2000/G3	CKSG2-2000/G3	Overall standard configuration
220G/250P	HKSG <sub>2</sub> -2200/G3	CKSG2-2200/G3	Overall standard configuration
250G/280P	HKSG <sub>2</sub> -2500/G3	CKSG2-2500/G3	Overall standard configuration
280G/315P	HKSG <sub>2</sub> -2800/G3	CKSG2-2800/G3	Overall standard configuration
315G/355P	HKSG <sub>2</sub> -3150/G3	CKSG2-3150/G3	Overall standard configuration
355G/400P	HKSG <sub>2</sub> -4000/G3	CKSG2-4000/G3	Overall standard configuration
400G/450P	HKSG <sub>2</sub> -4000/G3	CKSG2-4000/G3	Overall standard configuration
450G/500P	HKSG <sub>2</sub> -5000/G3	CKSG2-5000/G3	Overall standard configuration
500G/560P	HKSG <sub>2</sub> -5000/G3	CKSG2-5000/G3	Overall standard configuration
560G/630P	HKSG <sub>2</sub> -6300/G3	CKSG2-6300/G3	Overall standard configuration

## Braking Unit (Optional Braking Resistor)

Model	Braking unit			Resistance value ( $\Omega$ )	Resistance power (W)	Braking torque (%)
	AC70	AC80C	AC200			
R75G/1R5P	Built-in function	Built-in function	Built-in function	750 $\Omega$	150W	100%
1R5G/2R2P				400 $\Omega$	300W	100%
2R2G/004P				250 $\Omega$	400W	100%
004G/5R5P				150 $\Omega$	500W	100%
5R5G/7R5P				100 $\Omega$	600W	100%
7R5G/011P				75 $\Omega$	780W	100%
011G/015P				50 $\Omega$	1200W	100%
015G/018P				40 $\Omega$	1500W	100%
018G/022P				32 $\Omega$	2000W	100%
022G/030P	optional built-in function	optional built-in function	optional built-in function	28 $\Omega$	2200W	100%
030G/037P				24 $\Omega$	3000W	100%
037G/045P	BU30-3-075			20 $\Omega$	3700W	100%
045G/055P	BU30-3-075			16 $\Omega$	4500W	100%
055G/075P	BU30-3-100			13 $\Omega$	5500W	100%
075G/093P	BU30-3-100			9 $\Omega$	7500W	100%
093G/110P	BU30-3-150			6.8 $\Omega$	9300W	100%
110G/132P	BU30-3-150			6.2 $\Omega$	11000W	100%
132G/160P	BU30-3-300			4.7 $\Omega$	13000W	100%
160G/185P	BU30-3-300			3.9 $\Omega$	15000W	100%
185G/200P	BU30-3-300			3.3 $\Omega$	17000W	100%
200G/220P	2*BU30-3-150			3 $\Omega$	18500W	100%
220G/250P	2*BU30-3-150			2.7 $\Omega$	20000W	100%
250G/280P	2*BU30-3-300			2.4 $\Omega$	22500W	100%
280G/315P	2*BU30-3-300			2 $\Omega$	25500W	100%
315G/355P	2*BU30-3-300			1.8 $\Omega$	30000W	100%
355G/400P	2*BU30-3-300			1.5 $\Omega$	33000W	100%
400G/450P	2*BU30-3-300			1.2 $\Omega$	42000W	100%
450G/500P	2*BU30-3-300			1.2 $\Omega$	42000W	100%
500G/560P	2*BU30-3-300			1 $\Omega$	42000W	100%
560G/630P	2*BU30-3-300			1 $\Omega$	50000W	100%

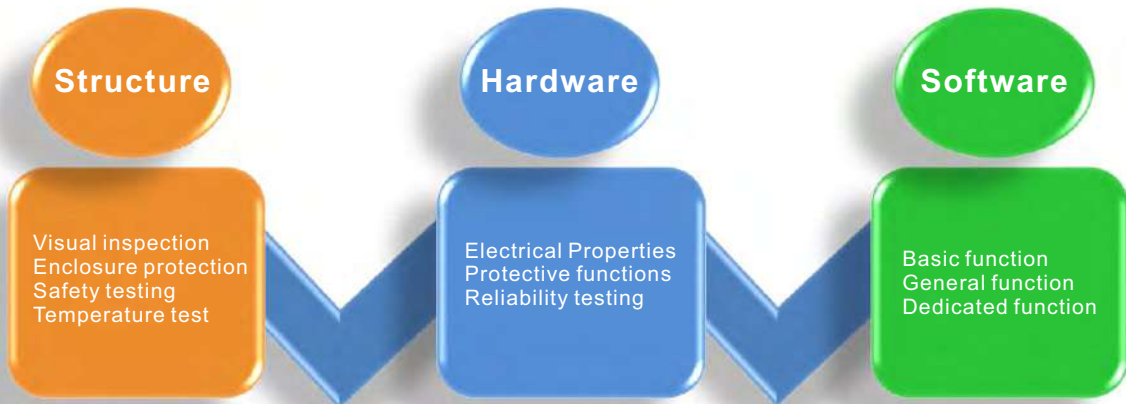
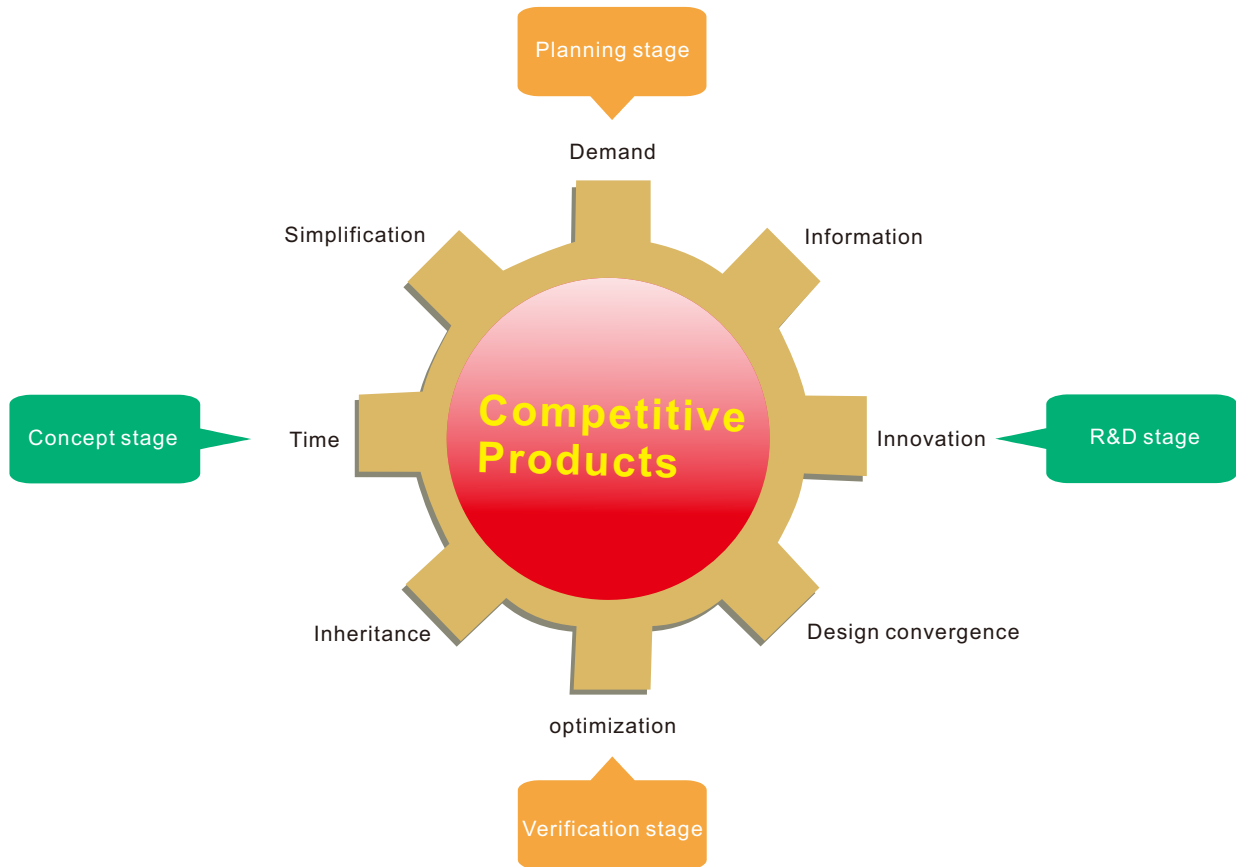



# Quality Assurance

## R&D Stage

Having advanced testing equipment, comprehensive testing program, rigorous testing standards to ensure product quality.

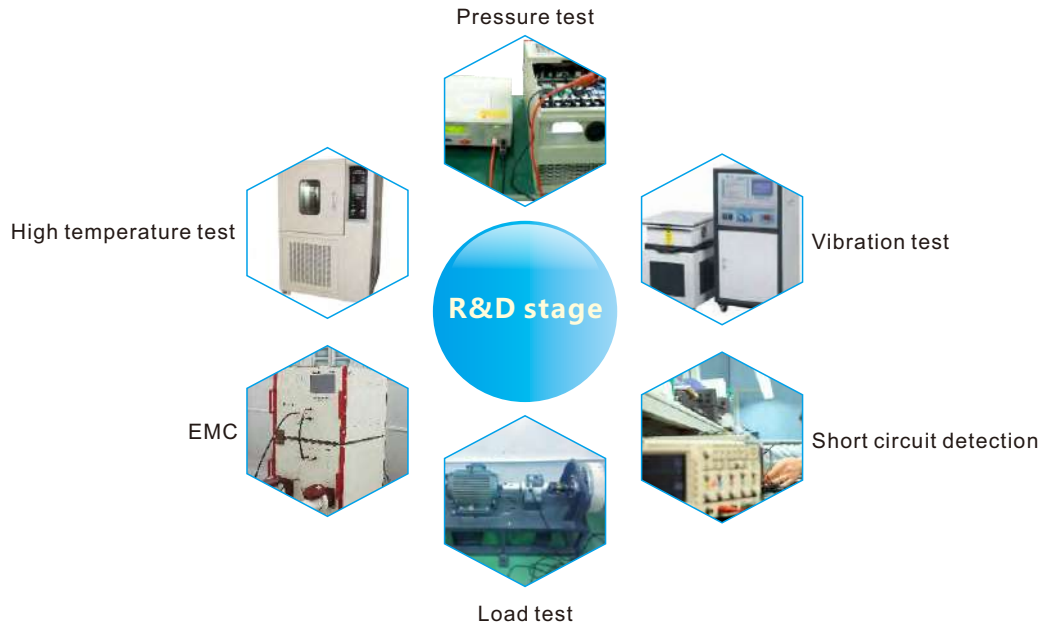

## Advanced Manufacturing Equipment



## Strict Quality Management System

Has strict quality management system and testing process to ensure that the supplied material qualities meet the specified standards; strict process control specifications and supervision will surely improve the finished product rate; FQC would do comprehensive and rigorous product checks to ensure that the final product performance, outlook and package can meet requirements.



PCB conformal coating process



Aging treatment



Debugging with motor

## Domestic Marketing Services Network



Veichi Electric was established in 2005 and headquartered in Shenzhen, China. In October 2013, Suzhou Veichi Electric Co., Ltd. was founded in Suzhou, Jiangsu province which formed two major production bases. Our sales and service network spread all over the country including more than 40 offices and service centers to ensure timely response of customer needs.

## International Sales Network

