

VEICHI

AC70 Vector Control AC Drive





Shenzhen Veichi Electric Co., Ltd is a high-tech enterprise that is professionally engaged in the development, manufacturing and marketing of industrial automation control products, and committed to becoming a global leading provider of industrial automation control products and system solutions.

The company owns powerful R&D team, relatively perfect production system, independent intellectual property and manufacturing bases in Shenzhen and Suzhou. To improve our R&D strength, we keep on introducing advanced overseas technology and broadening our partnerships with first-class universities and research institutions.

The main products of Veichi Electric include a variety of Variable Frequency Drive(VFD), Servo Drive System, Photovoltaic drive, PLC, HMI, Automation Equipment, etc, which are widely used in industries such as oil&gas, chemical industry, ceramic, crane&hoist, metallurgy, electrical cable and wire, plastic, print and package, textile, metal work and cable, coal mining and municipal engineering. Suitable solutions and products are always ready to meet the demands and improve comprehensive competitiveness of users.

With the spirit of "Innovation is the lifeblood of Veichi", we're committed to becoming one of the leading providers of electric drives, industrial control and green energy products. Veichi has set up more than 40 brand offices in China and dozens of partners in Asia, Europe and Africa. Veichi has been named Chinese Electric Industry's Top Ten National Brands, Chinese Electric Industry Top Ten Satisfying Brands and Top Ten National Brands of drive Industry. Veichi products have become the first choice of many enterprises.

AC70

Vector Control AC Drive

220V level (single phase) 0.4KW - 2.2KW

220V level (Three phase) 0.75KW- 30KW

380V level (Three phase) 0.75KW-1000KW

660V level (Three phase) 7.5KW - 1000KW

1140V level (Three phase) 30KW - 1100KW



High stability

High Precision

High responsiveness



Cost-effective

Environmental adaptability

Friendly interface

Vector control without PG torque response speed.

Vector control without PG torque precision control.

Vector control without PG:150% rated torque when 1Hz.

Wide voltage range:Allowable voltage fluctuation range.

Super overload capacity:150% rated current 60 seconds.

180% of rated current 2 seconds,200% moment trip.

Component life design,extending product lifetime.

Compact,ultra-small size design,adapt to different types of loads challenges.

Independent duct design,improve the anti-dust capability, penetrating installation,more adaptable.

Removable DC fan design to ensure quiet and smooth operation,easy for cleaning and replacement.

Keyboard plug and play,support external access,Chinese/ English panel supporting data copying.



Two drive control modes

○ V / F control

The control mode is used in all variable speed control that does not require fast response speed and high-precision control and in situations where one drive connecting multiple motors; and the mode can be used when the motor parameters are not clear or can not use the self-study.

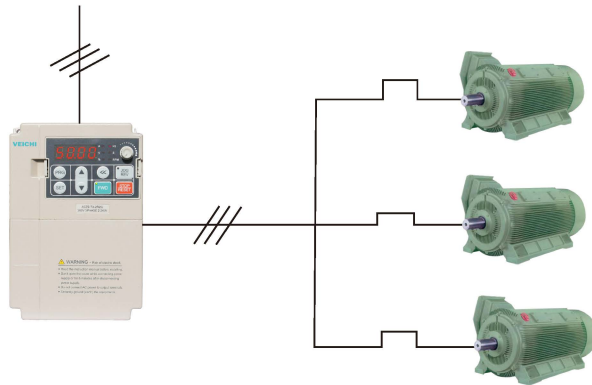

○ Vector control without PG

This mode is used in all variable speed control, when the high-accuracy speed control is needed, please set to this mode, which has rapid torque response, and a large torque can be obtained in low speed running.

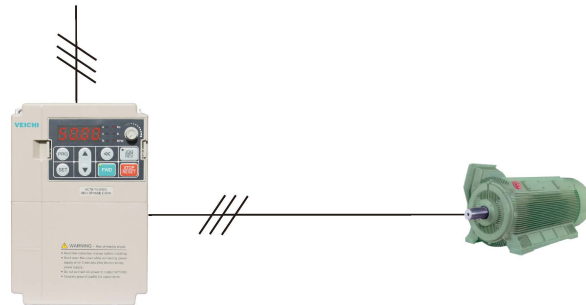

Best use: suitable for stamping machinery requiring instantaneous high torque and fast response current.

Rich self-study function

Rotating self-study and static self-study can be selected through parameter settings

Static self-study

The mode is most suitable when motor and load can not be disengaged, when motor and gear box is connected to make accurate electrical parameters after self-study, thereby obtaining a high starting torque, high-speed, and high-precision control.

Rotating auto tuning

This mode is most suitable when motor and load can be disengaged or no-load running situation. So the mechanical equipment can obtain high starting torque, high-speed, and high-precision control.

Speed tracking mode

In light load one AC drive can drive several motors to start tracking and to optimize the hardware and software tracking function, in which case the speed tracking precision and reliability are much higher.

1 100A/ 2 10.0V/ 3 4 2.220s 1.000s/ 停止 2 12.0V

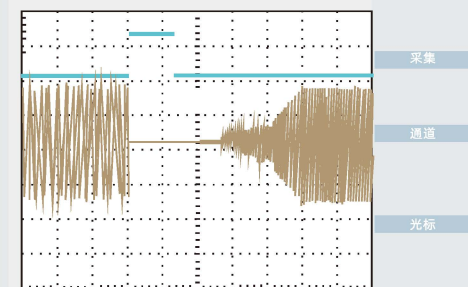

Software Tracking

1 100A/ 2 10.0V/ 3 4 2.220s 1.000s/ 停止 2 12.0V

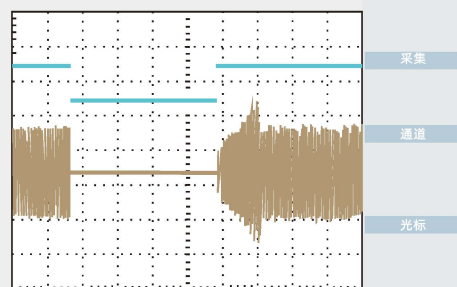

Hardware Tracking

Best Uses: Suitable for mechanical equipment such as fans, blowers that are equipped with a rotary device.

Standard swing frequency function

- The main purpose is to avoid wobble when winding and reduce static electricity.
- The thread is better than the thread produced by equipment without this feature, which improves the quality and production efficiency of the product.

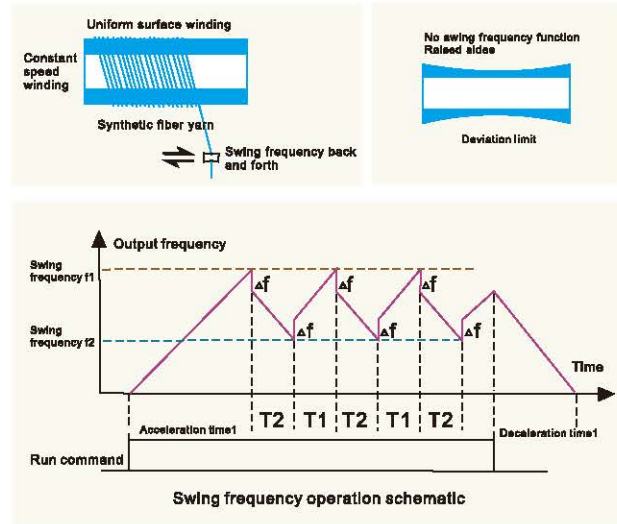

Best use: suitable for chemical fiber and other places, the parameters can be freely set by the swing frequency amplitude, speed and other relevant parameters.

Multiple PID controls

PID control is divided into ordinary PID and closed-loop pressure special PID with a broader scope and more specific feature.

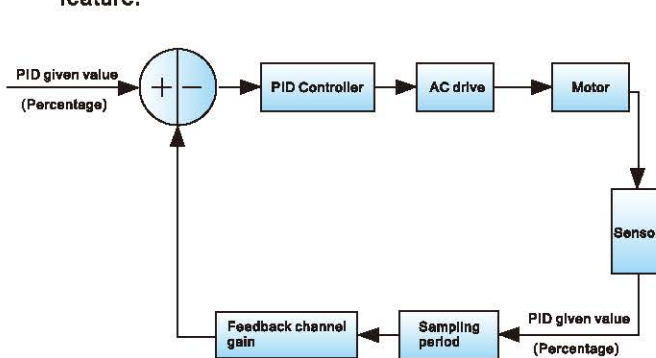

PID control schematic

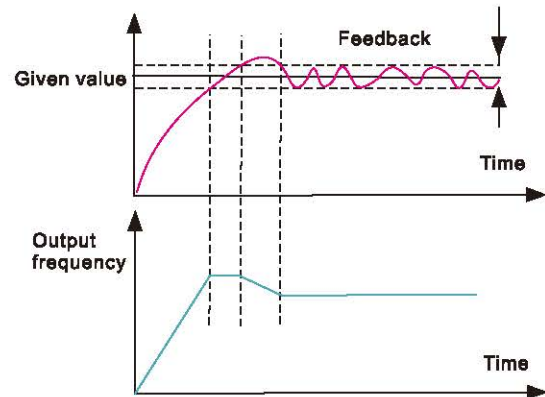

PID control deviation limit schematic

Best Uses: Suitable for fluid machinery, such as fans, pumps, blowers, etc.

Energy saving

- A new generation of energy-saving operation, the use of energy-saving frequency conversion control can achieve high efficiency operation of induction motor.
- In operation, the drive automatically calculates the optimum output voltage and supplies it to the load in order to achieve the purpose of saving energy.

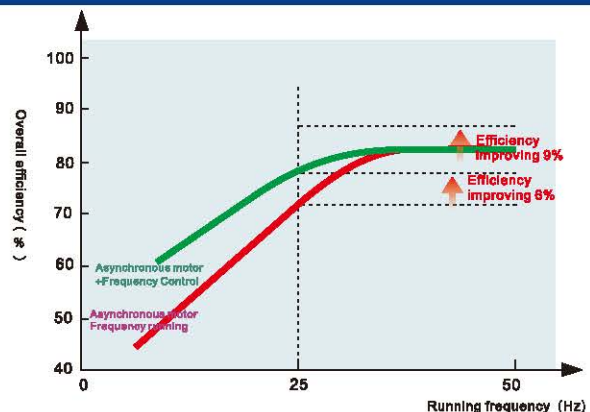

380V 4.0KW Application cases of fans and pumps

Load resilience

- Automatic current limiting technology, automatic frequency control technology to deal with the load mutations.
- Avoid frequent trouble on the drive, affecting productivity, ensure its rapid response.

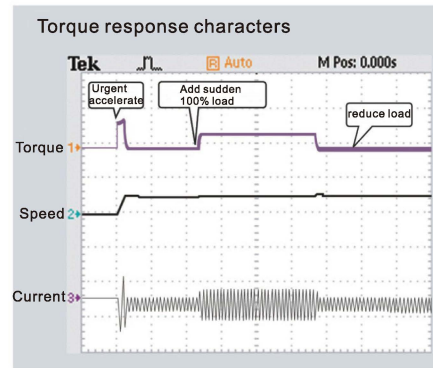

Best use: suitable for injection molding machine, EPS power supply, ball mill and other impact loads.

Professional instantaneous stop without power off algorithm to deal with interference electricity of power grid.

In a lighter load or high inertia loads instantaneous power compensation can be implemented.

- Eliminating the need for UPS (uninterruptible power supply), and other special equipment. When low voltage is detected, automatic instantaneous power compensation can be implemented.
- Search free-running state speed, easily re-start to improve the reliability of the whole system.

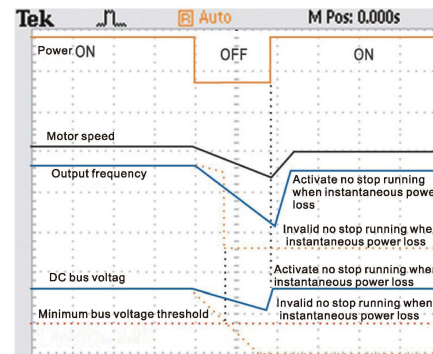

Best Uses: Suitable for dehydration machine, film production line, fans, pumps and other devices that need instantaneous power control.

Communication method

- Standard RS485 communication, support PROFIBUS-DP communication protocol.
- Convenient for the achievement of PC and PLC connection to realize remote monitoring.

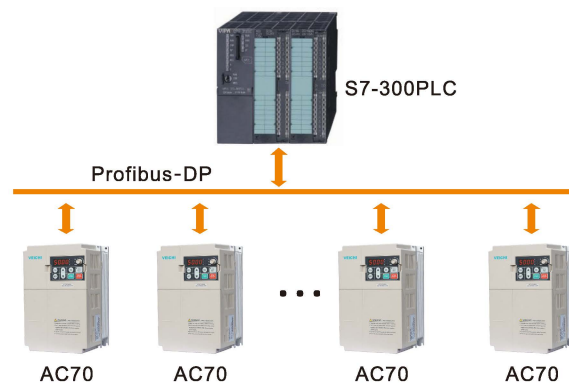

Best use: suitable for industrial control, smart instrumentation and other site communications needs.

You can use a DC power supply

- DC power supply can be used directly, especially for the common DC bus program and EPS power supply.
- Energy efficient, environmentally friendly and economic.

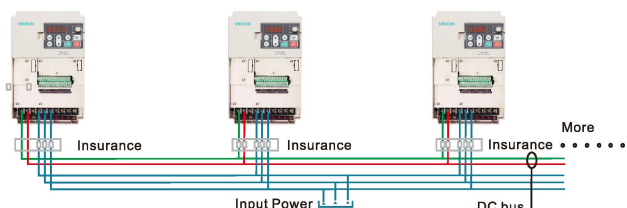

Random carrier function

Random carrier function can effectively reduce motor noise and suppress frequency interference on external devices.

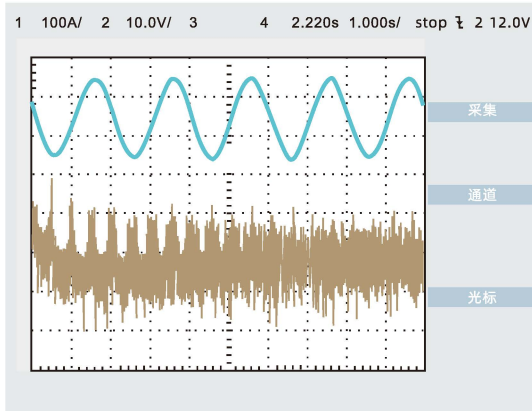

Interference signal under fixed-carrier is strong

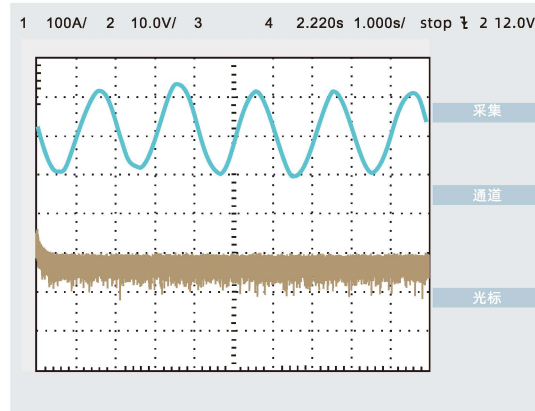

Noise can be effectively reduced in random carrier

Mounting mode

- Full range of DC fan, easy to replace with longer life. Penetrating installation, more adaptable.
- Cabinet machine adopts up and down design with standard chokes mounted on the base so that the cooling is better, improving the life of the machine, at the same time the wiring is more beautiful.

AC70 drive penetrating installation diagram

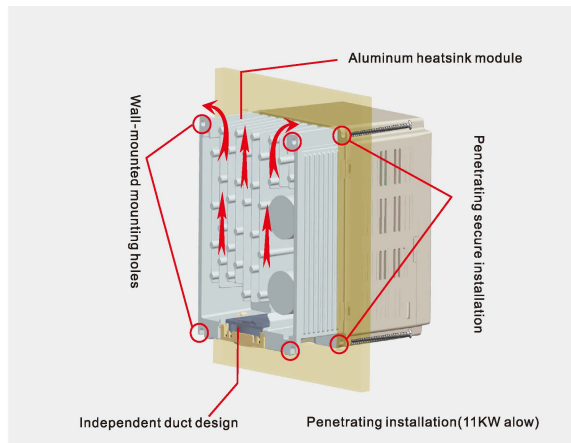

Environmental resistance design

- Three anti-treatment
PCB three anti-paint treatment: anti-moisture, anti-salt, anti-fungal.
- Protection class
Protection class is IP20, higher protection class products can be customized.
- Equipped with moisture, dust resistant, vibration-resistant reinforced products.

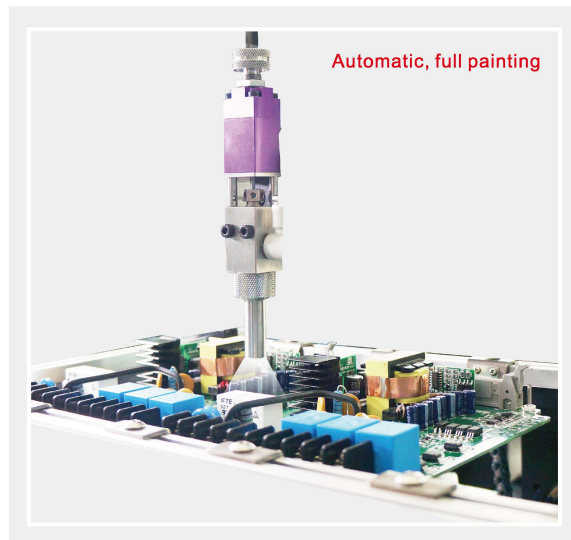

Solutions of AC70 Series on Compressor

1. Save energy.
2. Reduce operating costs.
3. Improve the accuracy of pressure control.
4. Extend the life of the compressor.
5. Reduce compressor noise.
6. PG without vector control, long-term operation at 20Hz according to the load characteristics of compressor.
7. Adaptable to the environment, wide input voltage, output voltage automatic voltage regulation (AVR function). Allowable range of input power; voltage $380V \pm 15\%$; frequency $50Hz \pm 15\%$.

Pressure Transmitters

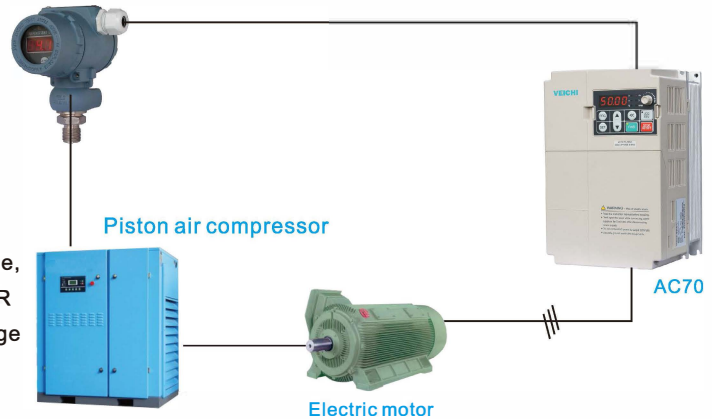

8. Built-in advanced PID algorithm, fast response, high constant pressure precision.
Set the target pressure and the actual feedback constant pressure to do the PID operation parameters, so that real-time speed adjustment can be implemented according to the gas situation, stepless adjustment of the motor speed, and the air compressor gas pressure remains constant, effectively improving the quality of working conditions.
9. International standard MODBUS communication protocol; frequency conversion control board with standard 485 communication module, convenient for the communication between the air compressor customer and air compressor controllers.
10. Provides users with up to 20 kinds of fault protection features to achieve full protection from the drive to the motor and the peripheral devices. Built-in lightning over current protection device effectively improves the self-protection of lightning.
11. When powering on the ac drive, the system would implement complete security system check of software and hardware, and securely protect the function parameters and settings to prevent wrong function parameter settings.

Suitable scope:



Solution of AC 70 Series on Drawing Machine

1. High-performance low-frequency torque characteristic.
2. Advanced built-in PID loop control algorithm.
3. High-speed control CPU core.
4. Complete fault protection function; perfect three anti-paint treatment process, EMC design adaptable to application environment.
5. Vector control technology, high-precision steady speed.
6. Simple system, 18.5KW and below built-in braking unit with no external device and it's low cost. The drive can fully achieve the main electrical control of wire drawing machine without external controller.
7. Reasonable factory parameters can be adapted in most suitable occasion.
8. Start logic control and coil diameter calculation function to ensure that the machine can smoothly start in any reel diameter; stable winding model can realize automatic identification, setting volume diameter and automatic tracking the host speed.
9. Parameter copy feature allows batch applications becoming more convenient.
10. High-speed/low-speed gear switching function can meet various requirements so that the drawing process becomes more energy efficient.

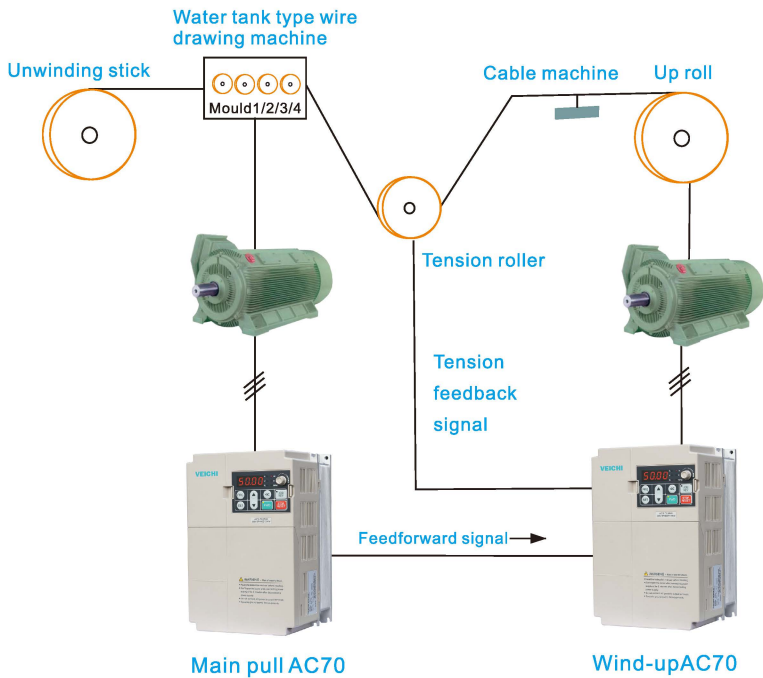

Suitable scope:

- Water tank type wire drawing machine
- Pulley wire drawing machine
- Linear drawing machine
- Dual-roll type wire drawing machine
- Looper wire drawing machine
-

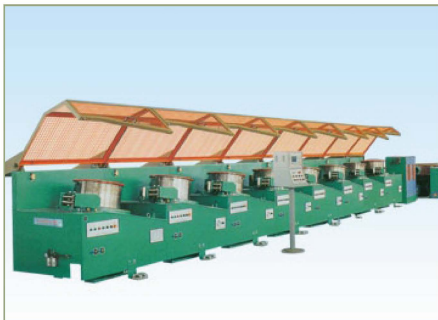

Solutions of AC70 Series Used on CNC Machine Tool

1. Simplified control circuits, various kinds of flexible control modes.
2. Convenient debugging. Users can debug various kinds of operating parameters via the intelligent keyboard and monitor. It is easy and flexible to set or change parameters within a short debugging time.
3. Large torque at low frequency. Comparing with similar products, AC70 has stronger ability in feed and cut which improves the working efficiency and productivity of CNC machine.
4. With Stable speed and open-loop vector control, AC70 greatly improves the manufacturing precision of CNC machine tool.
5. Compact structure design.
6. The output frequency of each range is stable. Its overload capacity is strong that the starting torque can reach 150% at 1.0Hz.
7. Fast dynamic torque response speed, faster acceleration and deceleration speed which reaches up to 0.1 seconds. It meets the processing requirements of mechanical devices and improves the working efficiency of each CNC machine.
8. Optimal limiting ability of current and voltage, super strong antimutagenicity capacity and overload ability, precise current loop control. When there is shock load or other external power grid disturbances, the trip protection is not apt to be triggered, better ensuring continuous and stable production of equipments.
9. Simplified servo function, precise poisoning from each random angle.
10. Various flexible control modes meet a wide variety of complex working conditions. It provides multiple output terminal signals such as fault output signals, running signals, speed signal and so on, which perfectly meets the requirement of system in monitoring the spindle speed state.

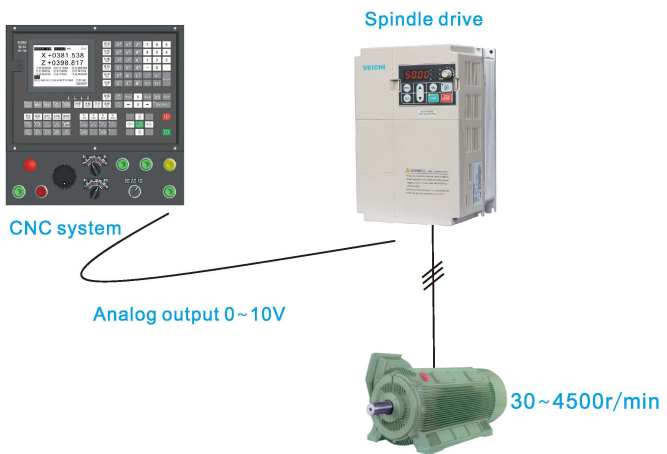

Suitable scope:

- Metal-cutting Machine Tool
- Forging Machine Tool
- Woodworking Machine Tool
- Lathe Machine Tool
- Crankshaft Machine Tool
-



Solutions of AC70 Series Used on Industrial Washing Machine

1. During the starting process, the industrial washing machine requires large starting torque as the clothes have absorbed water. AC70 can provide enough starting torque at low frequency and maintain stable starting.
2. During the washing process, the running frequency is between 8-15Hz and there is eccentric load. The powerful torque and slip compensation of AC70 ensures the stability of washing process.
3. During the uniform distribution process of clothes, the speed increases gradually with serious eccentric load. The overcurrent suppress function effectively adjusts speed fluctuation during the eccentric status.
4. During the dewatering process, washing machine requires that the variable frequency drives can run stably at high speed. The wide frequency range ensures dewatering processes at one go.
5. Stable performance. AC70 with brand-new design ensures the stable running of industrial washing machine in severe environment such as high humidity and high temperature.
6. Allowance design of IGBT module suits long-time regular positive and reverse rotating running at large current.
7. AC70 adopts special PWM which solves motors' requirements of starting at low frequency and weakening flux at high frequency.
8. Thickened conformal coating suits high temperature and humid environment.
9. Unique voltage and frequency curves, various multi-speed control mode.
10. Powerful low frequency load capacity and braking capacity.



Suitable scope:

Automatic type

Normal type

Semi-automatic type

.....



Solutions of AC70 Series in Construction Lifting Area

1. Wide voltage range design meets severe power grid.
2. Obvious energy-saving effect. Usually it saves up to 20% energy.
3. Precise torque control, dynamic response speed and "S" shape running speed curve that it ensures the smooth acceleration and deceleration with no impact sensitivity.
4. Complete protection function, high security and strong anti-interference ability.
5. AC70 provides stable and high output torque at low frequency section as well as strong overload capacity.
6. With perfect conformal coating treatment, independent air duct design and wide voltage range design, AC70 can meet application environment of various industries and harsh power environments.
7. With DC braking, energy consumption braking and more braking modes, AC70 maintains the construction elevators running more reliably and heavy-load parking more stably. It also has precise torque control and stall prevention function.
8. AC70 combines CPU centralized control and PLC circuit interface, which maintains speed control system with high reliability and increases the system's anti-inference ability. Meanwhile, it takes advantage of CPU's powerful control functions to achieve flexible control modes.
9. It is capable of achieving soft start and soft stop with reduced mechanical wear which makes the running more stable and reliable. AC70 ensures high security and accurate parking position that the no-load parking position is consistent with the heavy-load parking position. It indirectly increases objective economic benefits.
10. Continuous and convenient speed adjustment. Sectional speed setting and continuous speed adjustment is supported. It features rich functions, stable performance, small size, low noise operation and more.

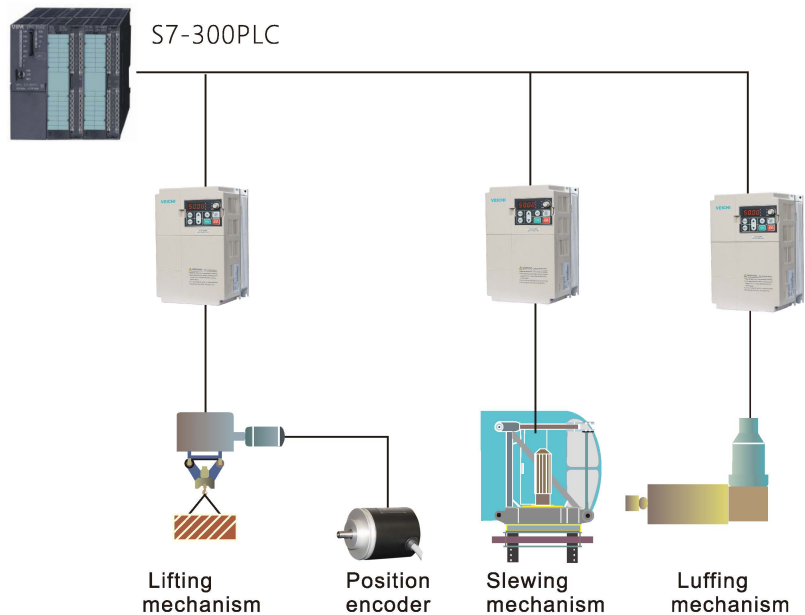

Suitable scope:

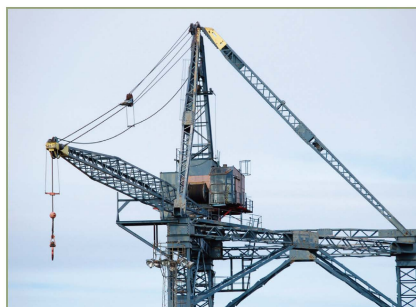

Standard Wiring Diagram

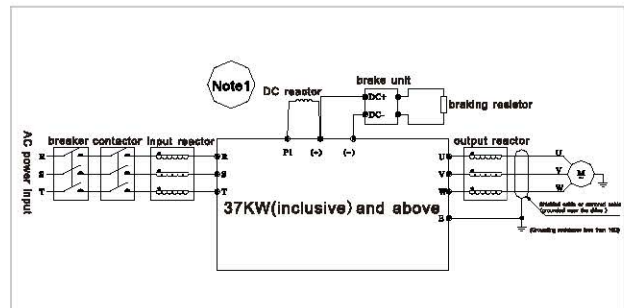
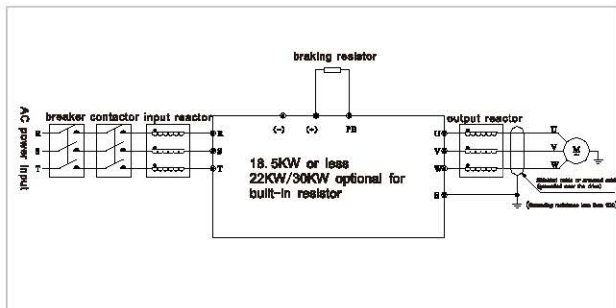
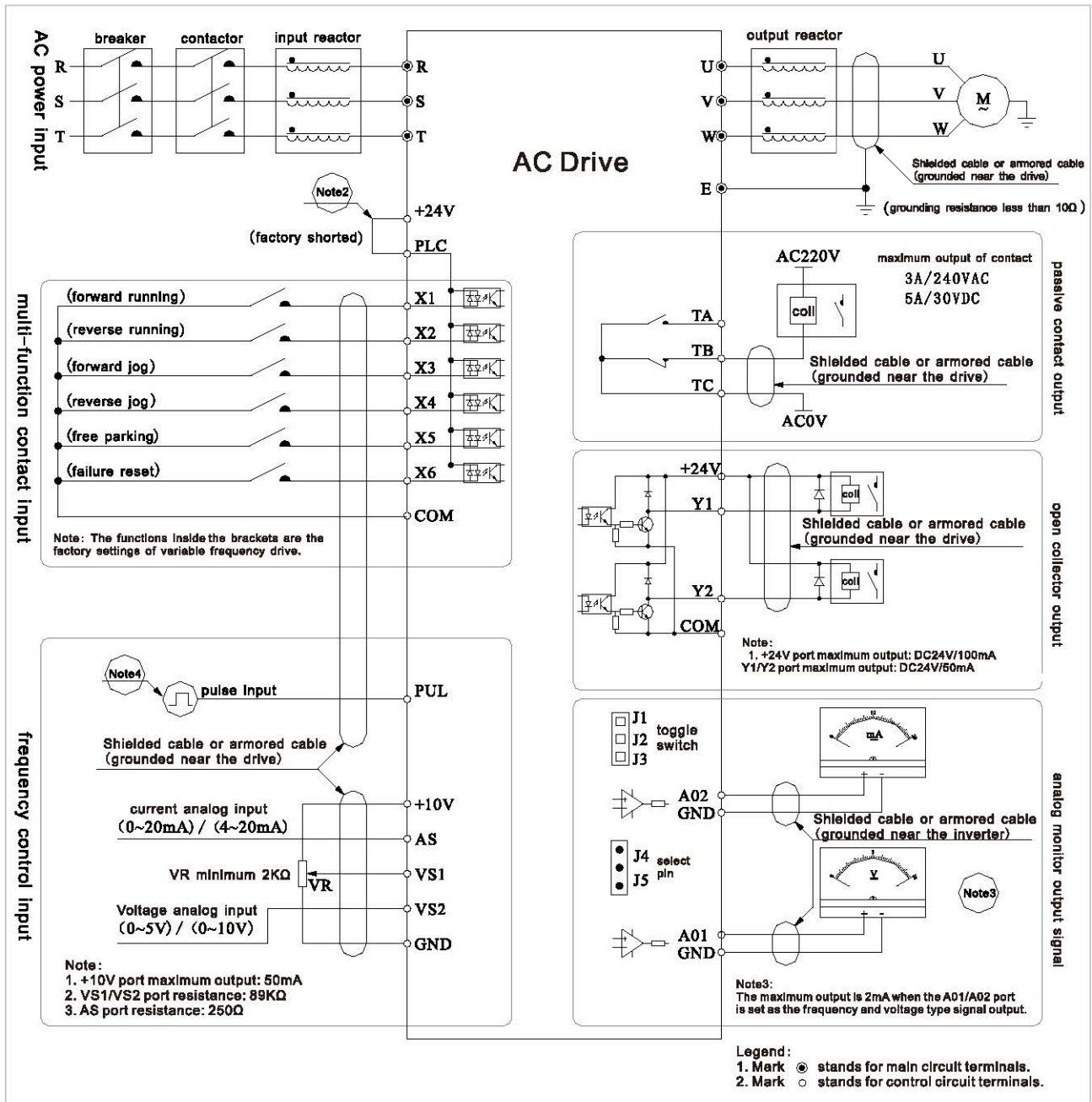

Note:

- When installing a DC reactor, be sure to remove the jumper between terminals P1, (+).
- Multi-function Input terminals (X1,X6) can select NPN or PNP transistor as the input signal, the bias voltage can select the internal power supply (+ 24V terminal), or you can choose an external power supply (PLC terminals) Preset "+ 24V" and "PLC" short.
- The analog monitor outputs are the outputs of frequency meter, ammeter, voltmeter and other special instruction, and they cannot be used for feedback control and other control operations.
- Due to the presence of various types of pulse practice, please refer to AC70 series manual for specific wiring scheme.

AC70 Installation Dimension

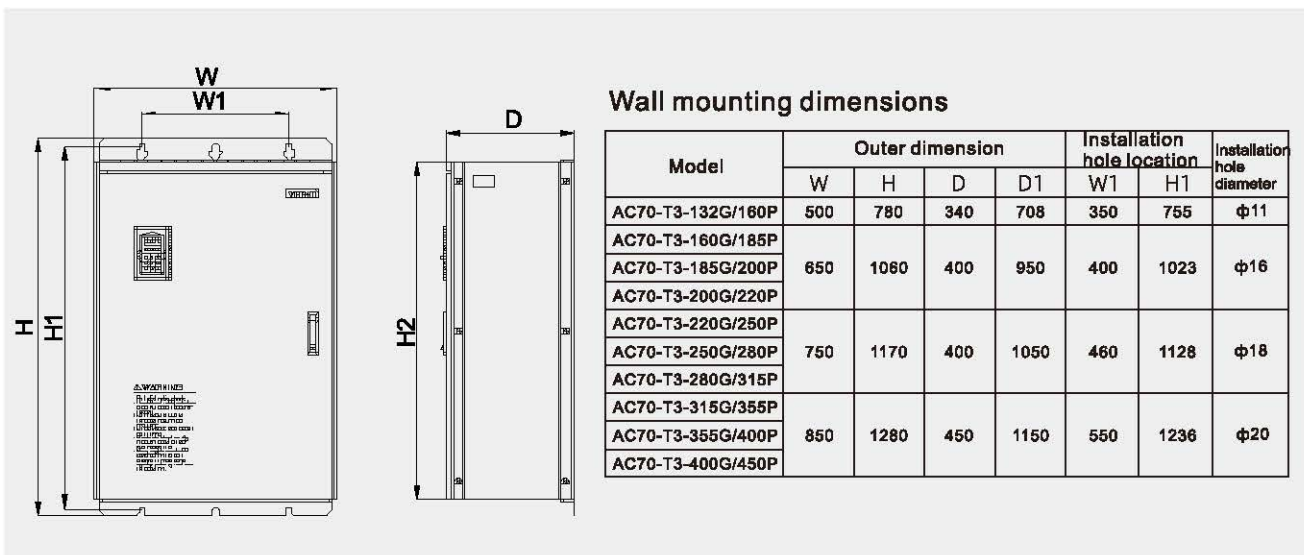
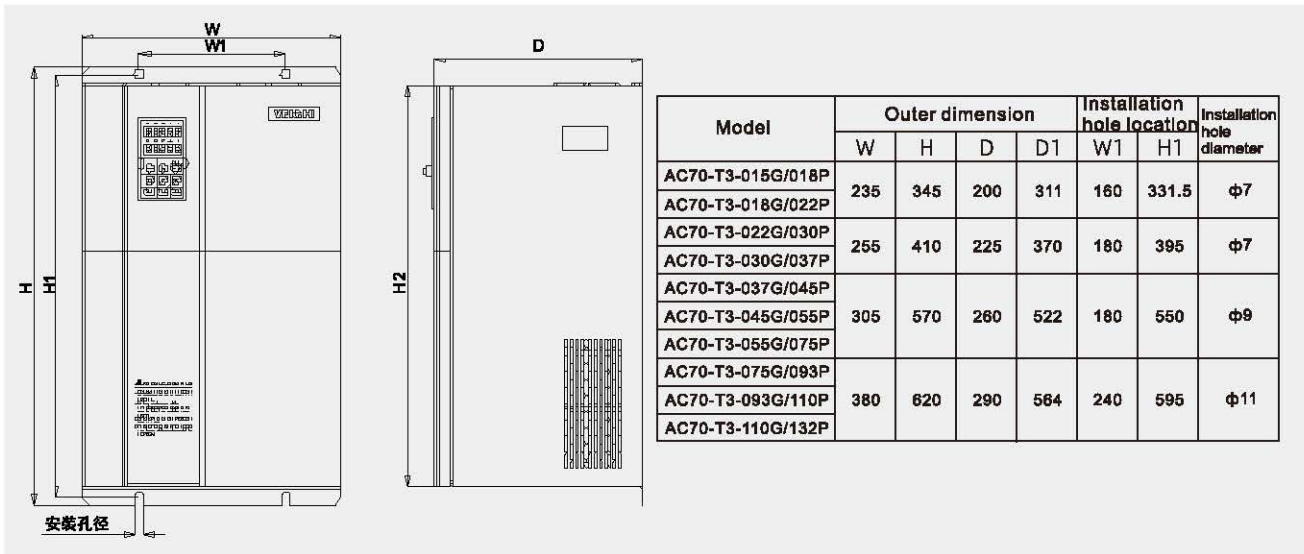
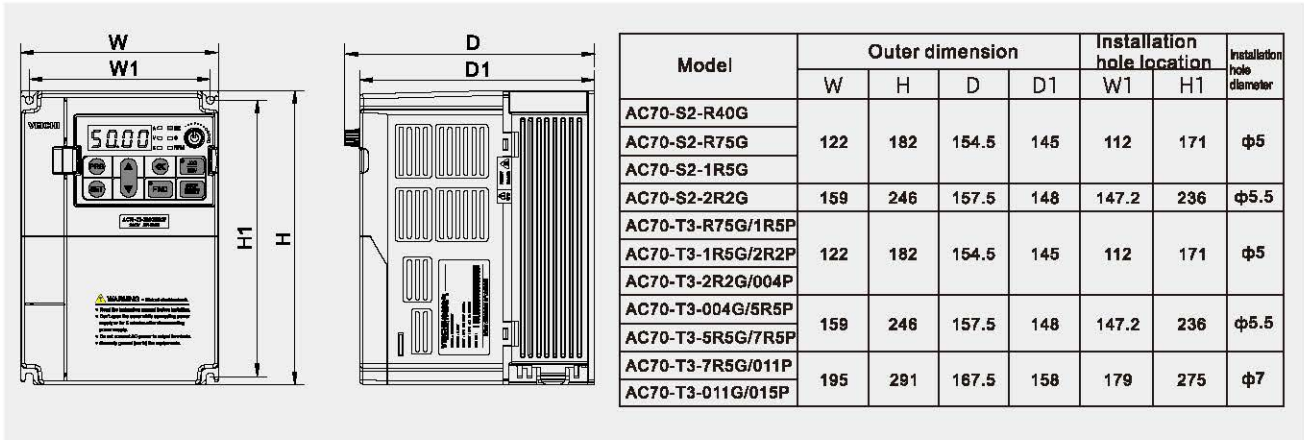

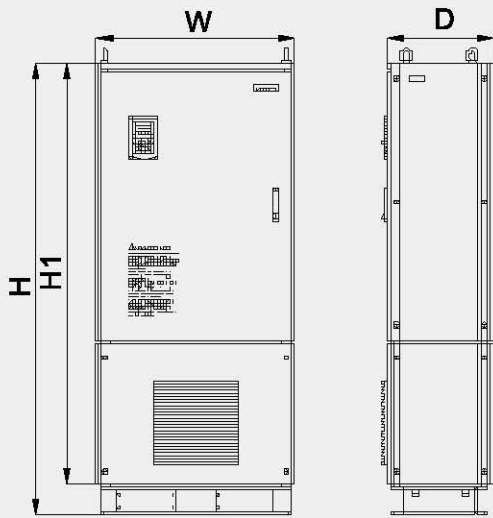

Cabinet mode installation dimension

Model	Outer dimension				Installation hole location		Installation hole diameter
	W	H	D	H1	W1	D1	
AC70-T3-160GD/185PD							
AC70-T3-185GD/200PD	650	1600	400	1500	492	332	φ14
AC70-T3-200GD/220PD							
AC70-T3-220GD/250PD							
AC70-T3-250GD/280PD	750	1700	400	1600	582	332	φ14
AC70-T3-280GD/315PD							
AC70-T3-315GD/355PD							
AC70-T3-355GD/400PD	850	1800	450	1700	622	382	φ14
AC70-T3-400GD/450PD							

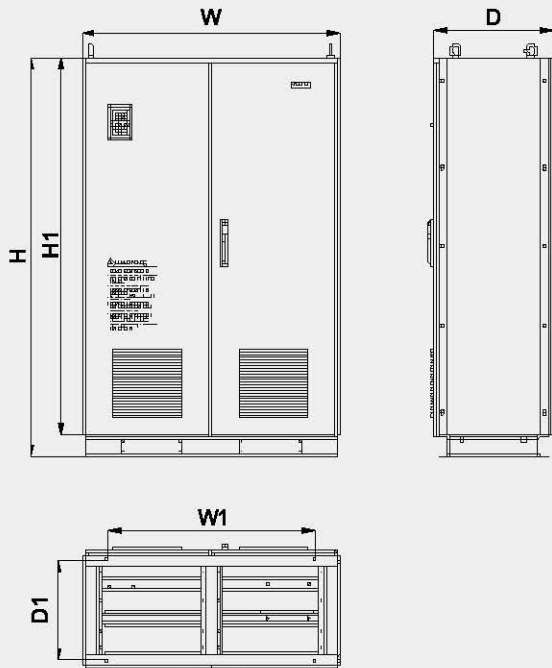
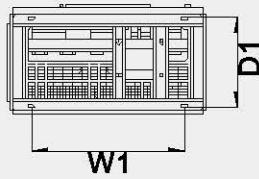

Model	Outer dimension				Installation hole location		Installation hole diameter
	W	H	D	H1	W1	D1	
AC70-T3-450G/500P							
AC70-T3-500G/560P	1200	1850	550	1750	960	466	φ14
AC70-T3-560G/630P							

VEICHI

Shenzhen Veichi Electric Co., Ltd

Block C, Wentao Science and Technology Park, Shiyan
Yingrenshi Community, Baoan District, Shenzhen, China

Tel: +86-755-2968 5610 (EXT 835)

Fax: +86-755-2968 5615 E-mail: overseas@veichi.com

Suzhou Veichi Electric Co., Ltd

No.111 Wusongjiang Avenue, Guoxiang Street, Wuzhong District, Suzhou, China

Service hotline :400-600-0303

[Http://www.veichi.com](http://www.veichi.com)



*Version:2016 V1.0
Shenzhen Veichi Electric Co., Ltd all rights
reserved, subject to change without notice.