

VEICHI



MANUAL

SIS4-1K-12-S

SIS4-1.5K-24-S

Table Of Contents

1	ABOUT THIS MANUAL	2
1.1	PURPOSE.....	2
1.2	SCOPE.....	2
2	SAFETY INSTRUCTIONS	2
3	INTRODUCTION	3
3.1	FEATURES.....	3
3.2	BASIC SYSTEM ARCHITECTURE.....	3
3.3	PRODUCT OVERVIEW.....	4
4	INSTALLATION	5
4.1	UNPACKING AND INSPECTION.....	5
4.2	PREPARATION.....	5
4.3	MOUNTING THE UNIT	5
4.4	BATTERY CONNECTION.....	5
4.5	AC INPUT/OUTPUT CONNECTION.....	7
4.6	PV CONNECTION.....	8
4.7	FINAL ASSEMBLY.....	9
5	OPERATION	9
5.1	POWER ON/OFF	9
5.2	OPERATION AND DISPLAY PANEL	9
5.3	LCD SETTING	10
5.4	DISPLAY SETTING.....	16
5.5	OPERATING MODE DESCRIPTION.....	19
5.6	BATTERY EQUALIZATION DESCRIPTION.....	20
5.7	FAULT REFERENCE CODE.....	22
5.8	WARNING INDICATOR.....	22
6	CLEARANCE AND MAINTENANCE FOR ANTI-DUST KIT	23
6.1	OVERVIEW.....	23
6.2	CLEARANCE AND MAINTENANCE	23
7	SPECIFICATIONS	24
	TABLE 1 LINE MODE SPECIFICATIONS	24
	TABLE 2 INVERTER MODE SPECIFICATIONS	25
	TABLE 3 CHARGE MODE SPECIFICATIONS	26
	TABLE 4 GENERAL SPECIFICATIONS.....	26

1 ABOUT THIS MANUAL

1.1 Purpose

This manual describes the assembly, installation, operation and troubleshooting of this unit. Please read this manual carefully before installations and operations. Keep this manual for future reference.

1.2 Scope

This manual provides safety and installation guidelines as well as information on tools and wiring.

2 SAFETY INSTRUCTIONS



WARNING: This chapter contains important safety and operating instructions. Read and keep this manual for future reference.

1. Before using the unit, read all instructions and cautionary markings on the unit, the batteries and all appropriate sections of this manual.
2. **CAUTION** --To reduce risk of injury, charge only deep-cycle lead acid type rechargeable batteries. Other types of batteries may burst, causing personal injury and damage.
3. Do not disassemble the unit. Take it to a qualified service center when service or repair is required. Incorrect re-assembly may result in a risk of electric shock or fire.
4. To reduce risk of electric shock, disconnect all wirings before attempting any maintenance or cleaning. Turning off the unit will not reduce this risk.
5. **CAUTION** – Only qualified personnel can install this device with battery.
6. **NEVER** charge a frozen battery.
7. For optimum operation of this inverter/charger, please follow required spec to select appropriate cable size. It's very important to correctly operate this inverter/charger.
8. Be very cautious when working with metal tools on or around batteries. A potential risk exists to drop a tool to spark or short circuit batteries or other electrical parts and could cause an explosion.
9. Please strictly follow installation procedure when you want to disconnect AC or DC terminals. Please refer to INSTALLATION section of this manual for the details.
10. **GROUNDING INSTRUCTIONS** -This inverter/charger should be connected to a permanent grounded wiring system. Be sure to comply with local requirements and regulation to install this inverter.
11. **NEVER** cause AC output and DC input short circuited. Do NOT connect to the mains when DC input short circuits.
12. **Warning!!** Only qualified service persons are able to service this device. If errors still persist after following troubleshooting table, please send this inverter/charger back to local dealer or service center for maintenance.

3 INTRODUCTION

This is a multi-function inverter/charger, combining functions of inverter, solar charger and battery charger to offer uninterruptible power support with portable size. Its comprehensive LCD display offers user-configurable and easy-accessible button operation such as battery charging current, AC/solar charger priority, and acceptable input voltage based on different applications.

3.1 Features

- Pure sine wave inverter
- Configurable input voltage range for home appliances and personal computers via LCD setting
- Configurable battery charging current based on applications via LCD setting
- Configurable AC/Solar Charger priority via LCD setting
- Compatible to mains voltage or generator power
- Auto restart while AC is recovering
- Overload/ Over temperature/ short circuit protection
- Smart battery charger design for optimized battery performance
- Cold start function

3.2 Basic System Architecture

The following illustration shows basic application for this inverter/charger. It also includes following devices to have a complete running system:

- Generator or Utility.
- PV modules

Consult with your system integrator for other possible system architectures depending on your requirements.

This inverter can power all kinds of appliances in home or office environment, including motor-type appliances such as tube light, fan, refrigerator and air conditioner (1.5HP).

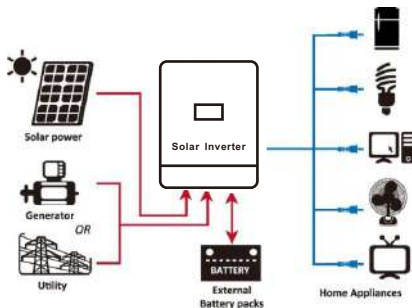
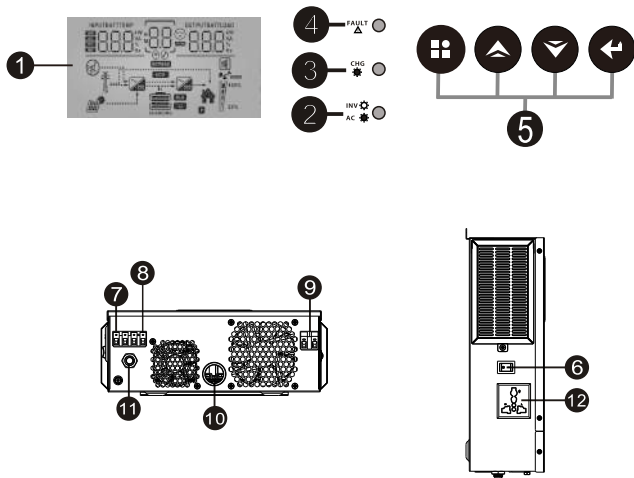

Figure 1 Hybrid Power System

3.3 Product Overview



1. LCD display
2. Status indicator
3. Charging indicator
4. Fault indicator
5. Function buttons
6. Power on/off switch
7. AC input
8. AC output
9. PV input
10. Battery input
11. Circuit breaker
12. Output receptacles

4 INSTALLATION

4.1 Unpacking and Inspection

Before installation, please inspect the unit. Be sure that nothing inside the package is damaged. You should have received the following items inside of package:

- The unit x 1
- User manual x 1
- U-terminal x 2

4.2 Preparation

Before connecting all wirings, please take off bottom cover by removing two screws as shown below.

4.3 Mounting the Unit

Consider the following points before selecting where to install:

- Do not mount the inverter on flammable construction materials.
- Mount on a solid surface
- Install this inverter at eye level in order to allow the LCD display to be read at all times.
- For proper air circulation to dissipate heat, allow a clearance of approx. 20 cm to the side and approx. 50 cm above and below the unit.
- The ambient temperature should be between 0°C and 55°C to ensure optimal operation.
- The recommended installation position is to be adhered to the wall vertically.
- Be sure to keep other objects and surfaces as shown in the diagram to guarantee sufficient heat dissipation and to have enough space for removing wires.



**SUITABLE FOR MOUNTING ON CONCRETE OR OTHER
NON-COMBUSTIBLE SURFACE ONLY.**

Install the unit by screwing two screws. It's recommended to use M4 or M5 screws.

4.4 Battery Connection

CAUTION: For safety operation and regulation compliance, it's requested to install a separate DC over-current protector or disconnect device between battery and inverter. It may not be requested to have a disconnect device in some applications, however, it's still requested to have over-current protection installed. Please refer to typical amperage in below table as required fuse or breaker size.

WARNING! All wiring must be performed by a qualified personnel.

WARNING! It's very important for system safety and efficient operation to use appropriate cable for battery connection. To reduce risk of injury, please use the proper recommended cable as below.

Recommended battery cable size:

Model	Wire Size	Cable (mm ²)	Torque value (max)
1.0KW 12V	1 x 6AWG	14	5 Nm
1.5KW 24V	1 x 6AWG	14	5 Nm

Please follow below steps to implement battery connection:

1. Remove insulation sleeve 18 mm for positive and negative conductors.
2. Suggest to put bootlace ferrules on the end of positive and negative wires with a proper crimping tool.

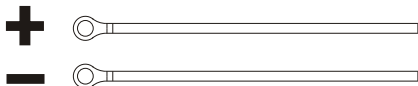

3. Connect all battery packs as below chart.

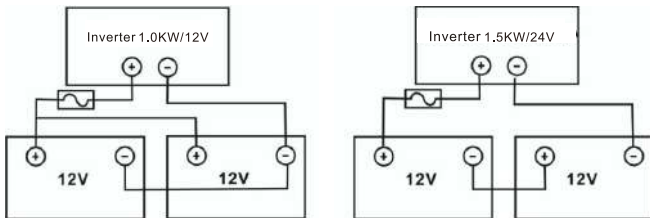

4. Insert the battery wires flatly into battery connectors of inverter and make sure the bolts are tightened with torque of 2 Nm in clockwise direction. Make sure polarity at both the battery and the inverter/charge is correctly connected and conductors are tightly screwed into the battery terminals.

Recommended tool: #2 Pozzi Screwdriver

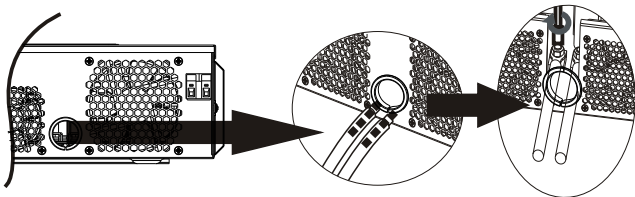

WARNING: Shock Hazard
Installation must be performed with care due to high battery voltage in series.

CAUTION!! Before making the final DC connection or closing DC breaker/disconnector, be sure positive (+) must be connected to positive (+) and negative (-) must be connected to negative (-).

4.5 AC Input /OutputConnection

CAUTION!! Before connecting to AC input power source, please install a **separate** AC breaker between inverter and AC input power source. This will ensure the inverter can be securely disconnected during maintenance and fully protected from over current of AC input. The recommended spec of AC breaker is 20A for 1.0KW and 20A for 1.5KW.

CAUTION!! There are two terminal blocks with "IN" and "OUT" markings. Please do NOT mis-connect input and output connectors.

WARNING! All wiring must be performed by a qualified personnel.

WARNING! It's very important for system safety and efficient operation to use appropriate cable for AC input connection. To reduce risk of injury, please use the proper recommended cable size as below.

Suggested cable requirement for AC wires

Model	Gauge	Torque Value
1.0KW 12V	14 AWG	2 Nm
1.5KW 24V	12 AWG	2 Nm

Please follow below steps to implement AC input/output connection:

1. Before making AC input/output connection, be sure to open DC protector or disconnecter first.
2. Remove insulation sleeve 10mm for six conductors. And shorten phase L and neutral conductor N 3 mm.
3. Insert AC input wires according to polarities indicated on terminal block and tighten the terminal screws. Be sure to connect PE protective conductor (⊕) first.

⊕ → **Ground (yellow-green)**

L → **LINE (brown or black)**

N → **Neutral (blue)**

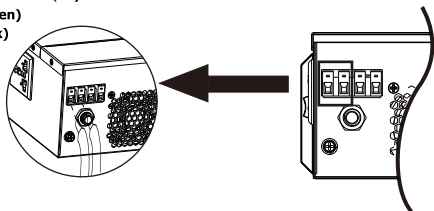

WARNING:

Be sure that AC power source is disconnected before attempting to hardwire it to the unit.

4. Then, insert AC output wires according to polarities indicated on terminal block and tighten terminal screws.

L → **LINE (brown or black)**

N → **Neutral (blue)**

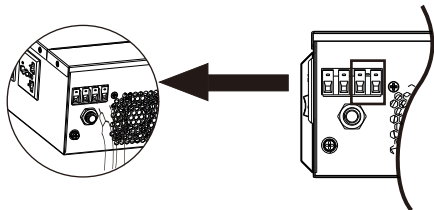

- Make sure the wires are securely connected.

CAUTION: Appliances such as air conditioner are required at least 2–3 minutes to restart because it's required to have enough time to balance refrigerant gas inside of circuits. If a power shortage occurs and recovers in a short time, it will cause damage to your connected appliances. To prevent this kind of damage, please check manufacturer of air conditioner if it's equipped with time-delay function before installation. Otherwise, this inverter/charger will trig overload fault and cut off output to protect your appliance but sometimes it still causes internal damage to the air conditioner.

4.6 PV Connection

CAUTION: Before connecting to PV modules, please install separately a DC circuit breaker between inverter and PV modules.

WARNING! It's very important for system safety and efficient operation to use appropriate cable for PV module connection. To reduce risk of injury, please use the proper recommended cable size as below.

Model	Wire Size	Torque value (max)
1.0KW 12V 1.5KW 24V	1x12AWG	2 Nm

PV Module Selection:

When selecting proper PV modules, please be sure to consider below parameters:

- Open circuit Voltage (Voc) of PV modules not exceeds max. PV array open circuit voltage of inverter.
- Open circuit Voltage (Voc) of PV modules should be higher than min. battery voltage.

INVERTER MODEL	1.0KW	1.5KW
Max. PV Array Open Circuit Voltage	150Vdc	
PV Array MPPT Voltage Range	20~150Vdc	30~150Vdc

Take 250Wp PV module as an example. After considering above two parameters, the recommended module configurations are listed as below table.

Solar Panel Spec. (reference)	SOLAR INPUT (Max in serial:4pcs)	Q'ty of panels	Total input power
- 250Wp	2 pcs in serial	2 pcs	500W
- Vmp: 30.1Vdc			
- Imp: 8.3A			
- Voc: 37.7Vdc			
- Isc: 8.4A	3 pcs in serial	3 pcs	750W
- Cells: 60	4 pcs in serial	4 pcs	1000W

PV Module Wire Connection

Please follow below steps to implement PV module connection:

- Remove insulation sleeve 10 mm for positive and negative conductors.
- Suggest to put bootlace ferrules on the end of positive and negative wires with a proper crimping tool.

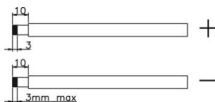

4. Check correct polarity of wire connection from PV modules and PV input connectors. Then, connect positive pole (+) of connection wire to positive pole (+) of PV input connector. Connect negative pole (-) of connection wire to negative pole (-) of PV input connector.
Recommended tool: 4mm blade screwdriver

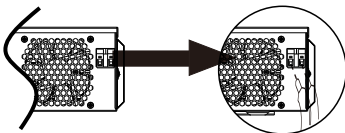

4.7 Final Assembly

After connecting all wirings, please put bottom cover back by screwing four screws as shown below.

5 OPERATION

5.1 Power ON/OFF

Side view of unit



Once you have made sure that all the wiring is properly connected, the machine is also connected to the battery and the switch (the switch button located on the side of the machine) is pressed to start the machine. Otherwise, even if the mains or photovoltaic power is connected, the machine will not be able to start.

5.2 Operation and Display Panel

The operation and display panel, shown in below chart, is on the front panel of the inverter. It includes three indicators, four function keys and a LCD display, indicating the operating status and input/output power information.

LCD display

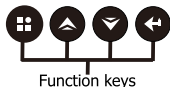

Function keys

LED Indicator

LED Indicator		Messages	
AC / INV	Green	Solid On	Output is powered by utility in Line mode.
		Flashing	Output is powered by battery or PV in battery mode.
CHG	Green	Solid On	Battery is fully charged.
		Flashing	Battery is charging.
FAULT	Red	Solid On	Fault occurs in the inverter.
		Flashing	Warning condition occurs in the inverter.

Function Keys

Function Key	Description
ESC	To exit setting mode
UP	To go to previous selection
DOWN	To go to next selection
ENTER	To confirm the selection in setting mode or enter setting mode

5.3 LCD Setting

After pressing and holding ENTER button for 3 seconds, the unit will enter setting mode. Press "UP" or "DOWN" button to select setting programs. And then, press "ENTER" button to confirm the selection or ESC button to exit.

Setting Programs:

Program	Description	Selectable option	
00	Exit setting mode	Escape 00 <u>GOE</u>	One-button restore setting options
		(default) 00 <u>GOH</u>	
01	Output source priority: To configure load power source priority	Utility first (default) 01 <u>USb</u>	Utility will provide power to the loads as first priority. Solar and battery energy will provide power to the loads only when utility power is not available.
		Solar first 01 <u>SUb</u>	Solar energy provides power to the loads as first priority. If solar energy is not sufficient to power all connected loads, utility will supply power to the loads at the same time. Battery provides power to the loads only when any one condition happens: - Solar energy and utility is not available. - Solar energy is not sufficient and utility is not available.
		SBU priority 01 <u>SbU</u>	Solar energy provides power to the loads as first priority. If solar energy is not sufficient to power all connected loads, battery energy will supply power to the loads at the same time. Utility provides power to the loads only when battery voltage drops to either low-level warning voltage or the setting point in program 12.
		MKS priority 01 <u>ntS</u>	When solar is available, solar energy and battery energy will supply power to the loads. when battery voltage drops to either low-level warning voltage or the setting point in program 12, the utility only supplies energy to the load as a back up power. When solar is not available, utility energy will supply power to the loads, the battery only supplies energy to the load as a back up power.

02	Maximum charging current: To configure total charging current for solar and utility chargers. (Max. charging current = utility charging current + solar charging current)	10A 02 <u>10</u> ^A	20A 02 <u>20</u> ^A
		30A 02 <u>30</u> ^A	40A (default) 02 <u>40</u> ^A
		50A 02 <u>50</u> ^A	60A 02 <u>60</u> ^A
		70A 02 <u>70</u> ^A	80A 02 <u>80</u> ^A
03	AC input voltage range	Appliances (default) 03 <u>APL</u>	If selected, acceptable AC input voltage range will be within 90-280VAC.
		UPS 03 <u>UPS</u>	If selected, acceptable AC input voltage range will be within 170-280VAC.
05	Battery type	AGM (default) 05 <u>AGM</u>	Flooded 05 <u>FLD</u>
		User-Defined 05 <u>USE</u>	If "User-Defined" is selected, battery charge voltage and low DC cut-off voltage can be set up in program 26, 27 and 29.
06	Auto restart when overload occurs	Restart disable (default) 06 <u>LTd</u>	Restart enable 06 <u>LT E</u>
07	Auto restart when over temperature occurs	Restart disable (default) 07 <u>TEd</u>	Restart enable 07 <u>TE E</u>
09	Output frequency	50Hz (default) 09 <u>50</u> _{Hz}	60Hz 09 <u>60</u> _{Hz}
10	Output voltage	220V 10 <u>220</u> ^V	230V (default) 10 <u>230</u> ^V
		240V 10 <u>240</u> ^V	

11	Maximum utility charging current Note: If setting value in program 02 is smaller than that in program in 11, the inverter will apply charging current from program 02 for utility charger.	2A 11 2A	10A 11 10A
		20A (default) 11 20A	30A 11 30A
		40A 11 40A	
12	Setting voltage point back to utility source when selecting "MKS priority" or "SBU priority" in program 01.	1.5KW 24V default setting: 23V 12 ^{BATT} 23.0 _v	
		1.0KW 12V default setting: 11.5V 12 ^{BATT} 11.5 _v	
		Setting range is from 21.0V to 26.2V for 1.5KW model 10.5V to 13.1V for 1.0KW model Increment of each click is 0.1V	
13	Setting voltage point back to battery mode when selecting "MKS priority" or "SBU priority" in program 01.	1.5KW 24V default setting: 27V 13 ^{BATT} 27.0 _v (default)	Battery fully charged 13 ^{BATT} FUL
		1.0KW 12V default setting: 13.5V 13 ^{BATT} 13.5 _v (default)	Battery fully charged 13 ^{BATT} FUL
		Setting range is from 24.0V to 29.2V for 1.5KW model 12V to 14.6V for 1.0KW model Increment of each click is 0.1V	
14	Maximum battery discharge current when selecting "SBU priority" in program 01	10A 14 10 ^A	20A (default) 14 20 ^A
		30A 14 30 ^A	40A 14 40 ^A

16	Charger source priority: To configure charger source priority	If this inverter/charger is working in Line, Standby or Fault mode, charger source can be programmed as below:	
		Solar first 16 <u>CS0</u>	Solar energy will charge battery as first priority. Utility will charge battery only when solar energy is not available.
		Solar and Utility (default) 16 <u>SNU</u>	Solar energy and utility will charge battery at the same time.
		Only Solar 16 <u>OSO</u>	Solar energy will be the only charger source no matter utility is available or not.
If this inverter/charger is working in Battery mode or Power saving mode, only solar energy can charge battery. Solar energy will charge battery if it's available and sufficient.			
18	Alarm control	Alarm on (default) 18 <u>6ON</u>	Alarm off 18 <u>6OF</u>
19	Auto return to default display screen	Return to default display screen (default) 19 <u>ESP</u>	If selected, no matter how users switch display screen, it will automatically return to default display screen (Input voltage /output voltage) after no button is pressed for 1 minute.
		Stay at latest screen 19 <u>1EP</u>	If selected, the display screen will stay at latest screen user finally switches.
20	Backlight control	Backlight on (default) 20 <u>LON</u>	Backlight off 20 <u>LOF</u>
22	Beeps while primary source is interrupted	Alarm on (default) 22 <u>AON</u>	Alarm off 22 <u>AOF</u>
23	Overload bypass: When enabled, the unit will transfer to line mode if overload occurs in battery mode.	Bypass disable (default) 23 <u>bYd</u>	Bypass enable 23 <u>bYE</u>



25	Record Fault code	Record enable (default) 25 FEN	Record disable 25 FDS
26	Bulk charging voltage (C.V voltage)	1.0KW 12V default setting: 14.1V CU 26 BATT 14.1V	
		1.5KW 24V default setting: 28.2V CU 26 BATT 28.2V	
		If self-defined is selected in program 5, this program can be set up. Setting range is from 12V to 15V for 1.0KW 12V model and 24V to 30V for 1.5KW 24V model. Increment of each click is 0.1V.	
27	Floating charging voltage	1.0KW 12V default setting: 13.5V FLU 27 BATT 13.5V	
		1.5KW 24V default setting: 27.0V FLU 27 BATT 27.0V	
		If self-defined is selected in program 5, this program can be set up. Setting range is from 12V to 15V for 1.0KW 12V model and 24V to 30V for 1.5KW 24V model. Increment of each click is 0.1V.	
29	Low DC cut-off voltage	1.0KW 12V default setting: 10.0V COU 29 BATT 10.0V	
		1.5KW 24V default setting: 20.0V COU 29 BATT 20.0V	
		If self-defined is selected in program 5, this program can be set up. Setting range is from 10.0V to 12.0V for 1.0KW 12V model and 20.0V to 24.0V for 1.5KW 24V model. Increment of each click is 0.1V. Low DC cut-off voltage will be fixed to setting value no matter what percentage of load is connected.	
30	Battery equalization	Battery equalization 30 EEN	Battery equalization disable (default) 30 EDS
		If "Flooded" or "User-Defined" is selected in program 05, this program can be set up.	

31	Battery equalization voltage	1.0KW 12V default setting: 14.6V EV 31 <u>14.6</u> ^{SET}	
		1.5KW 24V default setting: 29.2V EV 31 <u>29.2</u> ^{SET}	
		Setting range is from 12V to 15V for 1.0KW 12V model and 24V to 30V for 1.5KW 24V model. Increment of each click is 0.1V.	
33	Battery equalized time	60min (default) 33 <u>60</u>	Setting range is from 5min to 900min. Increment of each click is 5min.
34	Battery equalized timeout	120min (default) 34 <u>120</u>	Setting range is from 5min to 900 min. Increment of each click is 5 min.
35	Equalization interval	30days (default) 35 <u>30d</u>	Setting range is from 0 to 90 days. Increment of each click is 1 day
36	Equalization activated immediately	Enable 36 <u>AE0</u>	Disable (default) 36 <u>Ad5</u>
		If equalization function is enabled in program 30, this program can be set up. If "Enable" is selected in this program, it's to activate battery equalization immediately and LCD main page will shows "EQ". If "Disable" is selected, it will cancel equalization function until next activated equalization time arrives based on program 35 setting. At this time, "EQ" will not be shown in LCD main page.	

5.4 Display Setting

The LCD display information will be switched in turns by pressing "Up" or "DOWN" key. The selectable information is switched as below order: input voltage/output voltage, input frequency, PV voltage, PV input current, PV input power, charging current, charging power, battery voltage, output frequency, output voltage, load percentage, load in VA, load in Watt, DC discharging current, main CPU Version.

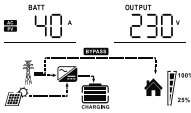
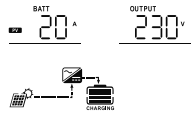
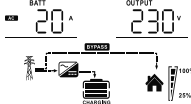

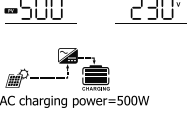
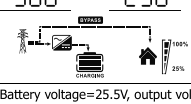
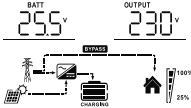

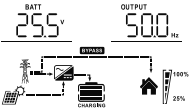
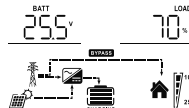
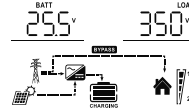
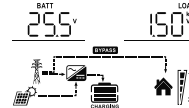
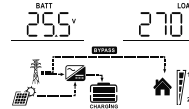
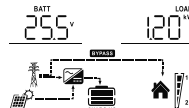

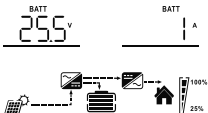
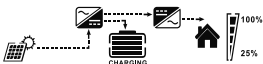
Selectable information	LCD display
Input voltage/Output voltage (Default Display Screen)	<p>Input Voltage=230V, output voltage=230V</p>
Input frequency	<p>Input frequency=50Hz</p>
PV voltage	<p>PV voltage=100V</p>
PV current	<p>PV current = 2.5A</p>
PV power	<p>PV power = 500W</p>

<p>Charging current</p>	<p>AC and PV charging current=40A</p>  <p>PV charging current=20A</p>  <p>AC charging current=20A</p> 
<p>Charging power</p>	<p>AC and PV charging power=500W</p>  <p>PV charging power=500W</p>  <p>AC charging power=500W</p> 
<p>Battery voltage and output voltage</p>	<p>Battery voltage=25.5V, output voltage=230V</p> 

<p>Output frequency</p>	<p>Output frequency=50Hz</p> 
<p>Load percentage</p>	<p>Load percent=70%</p> 
<p>Load in VA</p>	<p>When connected load is lower than 1kVA, load in VA will present xxxVA like below chart.</p>  <p>When load is larger than 1kVA ($\geq 1\text{kVA}$), load in VA will present x.xxkVA like below chart.</p> 
<p>Load in Watt</p>	<p>When load is lower than 1kW, load in W will present xxxW like below chart.</p>  <p>When load is larger than 1kW ($\geq 1\text{kW}$), load in W will present x.xxkW like below chart.</p> 

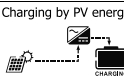
<p>Battery voltage/DC discharging current</p>	<p>Battery voltage=25.5V, discharging current=1A</p> 
<p>Main CPU version checking</p>	<p>Main CPU version 20 11</p> 

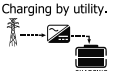
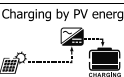
5.5 Operating Mode Description

Operation mode	Description	LCD display
<p>Standby mode / Power saving mode</p> <p>Note:</p> <p>*Standby mode: The inverter is not turned on yet but at this time, the inverter can charge battery without AC output.</p> <p>*Power saving mode: If enabled, the output of inverter will be off when connected load is pretty low or not detected.</p>	<p>No output is supplied by the unit but it still can charge batteries.</p>	<p>Charging by utility and PV energy.</p>  <p>Charging by utility.</p>  <p>Charging by PV energy.</p>  <p>No charging.</p> 
<p>Fault mode</p> <p>Note:</p> <p>*Fault mode: Errors are caused by inside circuit error or external reasons such as over temperature, output short circuited and so on.</p>	<p>PV energy and utility can charge batteries.</p>	<p>Charging by utility and PV energy.</p>  <p>Charging by utility.</p>  <p>Charging by PV energy.</p>  <p>No charging.</p> 

Operation mode	Description	LCD display
Line Mode	The unit will provide output power from the mains. It will also charge the battery at line mode.	<p>Charging by utility and PV energy.</p>
	The unit will provide output power from the mains. It will also charge the battery at line mode.	<p>Charging by utility.</p>
		<p>If "solar first" is selected as output source priority and solar energy is not sufficient to provide the load, solar energy and the utility will provide the loads and charge the battery at the same time.</p>
Battery Mode	The unit will provide output power from battery and PV power.	<p>Power from battery and PV energy.</p>
		<p>PV energy will supply power to the loads and charge battery at the same time.</p>
		<p>Power from battery only.</p>

5.6 Battery Equalization Description

Equalization function is added into charge controller. It reverses the buildup of negative chemical effects like stratification, a condition where acid concentration is greater at the bottom of the battery than at the top. Equalization also helps to remove sulfate crystals that might have built up on the plates. If left unchecked, this condition, called sulfation, will reduce the overall capacity of the battery. Therefore, it's recommended to equalize battery periodically.

• How to Apply Equalization Function

You must enable battery equalization function in monitoring LCD setting program 30 first. Then, you may apply this function in device by either one of following methods:

1. Setting equalization interval in program 35.
2. Active equalization immediately in program 36.

- **When to Equalize**

In float stage, when the setting equalization interval (battery equalization cycle) is arrived, or equalization is active immediately, the controller will start to enter Equalize stage.

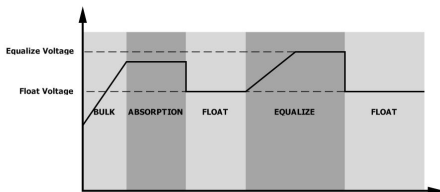

- **Equalize charging time and timeout**

In Equalize stage, the controller will supply power to charge battery as much as possible until battery voltage raises to battery equalization voltage. Then, constant-voltage regulation is applied to maintain battery voltage at the battery equalization voltage. The battery will remain in the Equalize stage until setting battery equalized time is arrived.

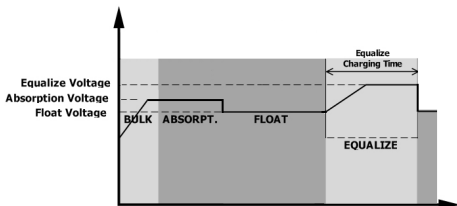

However, in Equalize stage, when battery equalized time is expired and battery voltage doesn't rise to battery equalization voltage point, the charge controller will extend the battery equalized time until battery voltage achieves battery equalization voltage. If battery voltage is still lower than battery equalization voltage when battery equalized timeout setting is over, the charge controller will stop equalization and return to float stage.

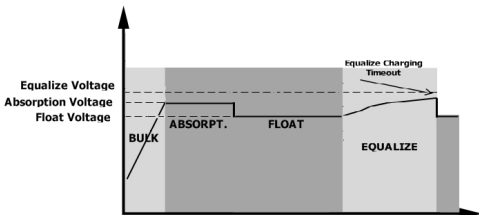

5.7 Fault Reference Code

Fault Code	Fault Event	Icon on
01	Fan is locked when inverter is off.	
02	Over temperature	
03	Battery voltage is too high	
04	Battery voltage is too low	
05	Output short circuited or over temperature is detected by internal converter components.	
06	Output voltage is too high.	
07	Overload time out	
08	Bus voltage is too high	
09	Bus soft start failed	
51	Over current or surge	
52	Bus voltage is too low	
53	Inverter soft start failed	
55	Over DC voltage in AC output	
57	Current sensor failed	
58	Output voltage is too low	
59	PV voltage is over limitation	

5.8 Warning Indicator

Warning Code	Warning Event	Audible Alarm	Icon flashing
01	Fan is locked when inverter is on.	Beep three times every second	
04	Low battery	Beep once every second	
07	Overload	Beep once every 0.5 second	
10	Output power derating	Beep twice every 3 seconds	
15	PV energy is low.	Beep twice every 3 seconds	
E9	Battery equalization	None	

6 CLEARANCE AND MAINTENANCE FOR ANTI -DUST KIT (Optional)

6.1 Overview

Every inverter is already installed with anti-dusk kit from factory. Inverter will automatically detect this kit and activate internal thermal sensor to adjust internal temperature. This kit also keeps dusk from your inverter and increases product reliability in harsh environment.

6.2 Clearance and Maintenance(option)

Step 1: Please remove screws as below.

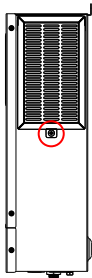

Step 2: Then, dustproof case can be removed and take out air filter foam as shown in below chart.

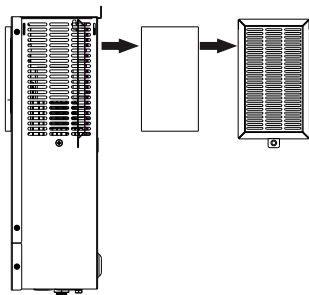

Step 3: Clean air filter foam and dustproof case. After clearance, re-assemble the dust-kit back to the inverter.

NOTICE: The anti-dust kit should be cleaned from dust every one month.

7 SPECIFICATIONS

Table 1 Line Mode Specifications

INVERTER MODEL	1.0KW-12V	1.5KW-24V
Input Voltage Waveform	Sinusoidal (utility or generator)	
Nominal Input Voltage	230Vac	
Low Loss Voltage	170Vac±10V (UPS); 90Vac±10V (Appliances)	
Low Loss Return Voltage	180Vac±10V (UPS); 100Vac±10V (Appliances)	
High Loss Voltage	280Vac±10V	
High Loss Return Voltage	270Vac±10V	
Max AC Input Voltage	300Vac	
Nominal Input Frequency	50Hz / 60Hz (Auto detection)	
Low Loss Frequency	40±1Hz	
Low Loss Return Frequency	42±1Hz	
High Loss Frequency	65±1Hz	
High Loss Return Frequency	63±1Hz	
Output Short Circuit Protection	Circuit Breaker	
Efficiency (Line Mode)	>95% (Rated R load, battery full charged)	
Transfer Time	10ms	
<p>Output power derating: When AC input voltage drops to 170V, the output power will be derated.</p>	 <p>The graph plots Output Power against Input Voltage. The y-axis represents Output Power, with two specific levels marked: 50% Power and Rated Power. The x-axis represents Input Voltage, with three key points marked: 90V, 170V, and 280V. The power curve starts at 50% of the rated power for input voltages between 90V and 170V. At 170V, the power begins to rise linearly, reaching the full Rated Power at 170V. This full Rated Power is maintained constant until the input voltage reaches 280V, after which the power drops to zero.</p>	

Table 2 Inverter Mode Specifications

INVERTER MODEL	1.0KW-12V	1.5KW-24V
Rated Output Power	1000VA/1000W	1500VA/1500W
Output Voltage Waveform	Pure Sine Wave	
Output Voltage Regulation	230Vac±5%	
Output Frequency	50Hz	
Peak Efficiency	94%	
Overload Protection	3s@ ≥150% load;5s@ 100% ~ 150% load	
Surge Capacity	2* rated power for 1 seconds	
Nominal DC Input Voltage	12Vdc	24Vdc
Cold Start Voltage	11.5Vdc	23.0Vdc
Low DC Warning Voltage @ load < 50%	11.25Vdc	22.5Vdc
@ load ≥ 50%	11.0Vdc	22Vdc
Low DC Warning Return Voltage @ load < 50%	11.75Vdc	23.5Vdc
@ load ≥ 50%	11.5Vdc	23Vdc
Low DC Cut-off Voltage @ load < 50%	10.75Vdc	21.5Vdc
@ load ≥ 50%	10.5Vdc	21Vdc
High DC Recovery Voltage	15.5Vdc	31Vdc
High DC Cut-off Voltage	16.0Vdc	32Vdc
No Load Power Consumption	<28W	<28W

Table 3 Charge Mode Specifications

Utility Charging Mode		
INVERTER MODEL	1.0 KW-12V	1.5KW-24V
Charging Algorithm		3-Step
AC Charging Current (Max)		40Amp (@ $V_{1/P}=230\text{Vac}$)
Bulk Charging Voltage	Flooded Battery	14.6
	AGM / Gel Battery	14.1
Floating Charging Voltage		13.5Vdc
Charging Curve		<p>The graph plots Battery Voltage (per cell) on the left y-axis and Charging Current (%) on the right y-axis against Time on the x-axis. The voltage curve (black) rises linearly in the Bulk stage, plateaus in the Absorption stage, and then slightly drops in the Maintenance stage. The current curve (red) is constant in the Bulk stage, then decays exponentially in the Absorption stage, and remains low in the Maintenance stage. Key time points T_1 and T_2 are marked on the x-axis. A note indicates $T_1 - 90^\circ\text{F}$ maximum (30°C maximum limit).</p>
MPPT Solar Charging Mode		
INVERTER MODEL	1.0KW-12V	1.5KW-24V
Max. PV Array Power		600W
PV Array MPPT Voltage Range		20~150Vdc
Max. PV Array Open Circuit Voltage		150Vdc
Max solar charging current		40Amp
Max(AC+Solar) Charging current		80Amp

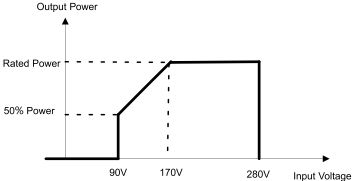
Table 4 General Specifications

INVERTER MODEL	1.0KW-12V	1.5KW-24V
Safety Certification	CE	
Operating Temperature Range	-10° C to 50° C	
Storage temperature	-15° C~ 60° C	
Humidity	5% to 95% Relative Humidity (Non-condensing)	
Dimension (D* W* H) , mm	286X240X91	
Net Weight, kg	3	3.5

技术要求:

- 1、尺寸：单页尺寸105*142mm；
- 2、材质：80g书写纸；
- 3、颜色：封面彩色CMYK印刷，内容黑白印刷；
- 4、印刷效果：图片、字体、线条需清晰，无重影，无毛边，无多余杂点；
- 5、料号打于后封面左下角；

*注:此技术要求不用印刷

VEICHI

SUZHOU VEICHI ELECTRIC CO.,Ltd.

Address:No.1000 Songjia road,Wuzhong Economic and

Technological Development Zone,Suzhou

Phone:+86-512-6617 1988

Facebook:<https://www.facebook.com/veichigroup>

Whatsapp:+86-138 2881 8903

E-mail:overseas@veichi.com Web:<https://www.veichi.org/>



Official Website

Version: 2023 V1.0