VH-0808ETP Module

Manual

V1.0

Archive date 2024-03-07

VEICHI Electric Co., Ltd. provides customers with all-round technical support. Please contact the nearest office or service center, or directly contact the company headquarters.

Suzhou VEICHI Electric Co., Ltd.

All rights reserved. Contents are subject to change without prior notice.

Suzhou VEICHI Electric Co., Ltd.

Address: 3rd Floor, Building ChunSheng, Lingya Industrial Park, No. 1 Road, Tangtou Community, Shiyan Street, Baoan District, Shenzhen, China

Hotline: 400-600-0303

Website: www.veichi.com

Preface

■ Brief

The VH-0808ETP series digital input/output expansion module features 8 channels of source type digital input and 8 channels of PNP transistor digital output. It can be used in conjunction with the VH series main modules.

■ Additional Materials

| Name | Content Summary |
|--|--|
| VH600 Series Programmable Logic Controller | Details instructions on installation, wiring, and operation. |
| VH-4AD Module Manual | Details instructions on installation, wiring, and operation. |
| VH100/300/500 | Details instructions on installation, wiring, and operation. |

■ Version Change Log

| Date | Version | Content |
|--------|---------|---------------|
| 2024-3 | V1.0 | First release |

■ Manual Acquisition

This manual is not shipped with products. To obtain the PDF file, please:

- Log on to the official website of VEICHI Electric (www.veichi.cn), "Services and Support-Data Download", search for keywords and download the PDF file.
- Scan the QR code on the product body to access eBOOK and obtain it.

■ Warranty Description

Under normal use, VEICHI provides an 18-month warranty for product malfunctions or damage (starting from the factory date, based on the barcode on the product body, and following contract terms if applicable). After 18 months, repair costs will be charged. Within the first 18 months, repair costs will be incurred for:

- Improper operation of the product without following the manual.
- Damage caused by fire, flood, or abnormal voltage.
- Damage caused by using the product for non-intended purposes.
- Damage caused by exceeding the product's specified usage range.
- Secondary damage caused by force majeure (natural disasters, earthquakes, lightning strikes).

The relevant service fee shall be calculated by the unified standard of the manufacturer. If there is a contract, terms in it will be of the highest priority.

Please refer to "Product Warranty Card" for details.

Precautions

■ Safety Statement

- Read and follow these safety precautions before installing, operating, or maintaining the product.
- Ensure personal and equipment safety by adhering to all safety instructions indicated on the product and described in the manual during installation, operation, and maintenance.
- The "Caution," "Warning," and "Danger" notices in the manual do not cover all of the safety precautions to be observed, but only supplement to safety precautions.
- Please use the product in an environment that meets the requirements of design specifications, otherwise it may cause failure, abnormal function or component damages, which is not within the scope of product quality assurance.
- VEICHI will not take on any legal responsibility for personal safety accidents and property damage caused by unauthorized operation of the product.

■ Safety Level



Failure to observe the precautions will cause serious personal injuries or deaths.



Failure to observe the precautions may cause serious personal injuries or deaths.



Failure to observe the precautions may cause slight personal injuries or product damages.

Please keep this manual safe for reference and ensure it is delivered to the end user.

| Control System Design | |
|-----------------------|--|
| | <ul style="list-style-type: none"> ➤ Ensure safety circuit design to maintain secure operation during power outages or controller failures; ➤ Install external safety devices like fuses or circuit breakers to prevent smoking or fire from overcurrent caused by load overloads or short circuits. |
| | <ul style="list-style-type: none"> ➤ Design emergency stop, protection, and interlock circuits for forward/reverse operations, and limit switches to prevent product damage in the PLC external circuits; ➤ Design external protective circuits and safety mechanisms for major accident-related output signals to ensure equipment safety; ➤ The programmable controller's CPU may shut down all outputs upon detecting system anomalies; design appropriate external control circuits to ensure normal operation in case of partial circuit failure; ➤ Damage to the PLC relays, transistors, or other output units may render their outputs uncontrollable in switching between ON and OFF states; ➤ The PLC is designed for indoor use in an overvoltage category II electrical environment; its power system should include lightning protection to prevent damage from overvoltage due to lightning strikes on power/signal input terminals, or control output terminals. |
| Installation | |
| | <ul style="list-style-type: none"> ➤ Only professionals with relevant maintenance training in electrical equipment and electrical knowledge can install this product; ➤ Disconnect all external power supplies before disassembling or assembling modules. Failure to do so may result in electric shock, module failure, or malfunction; ➤ Do not use the PLC in environments with dust, fumes, conductive dust, corrosive gases, flammable gases; exposed to high temperatures, condensation, wind, or rain; or in areas with vibration or impact. Electrical shock, fire, and misoperation can damage and deteriorate the product; |

- As the PLC is an open type device, install it in a control cabinet (enclosure protection > IP20) with a lock, accessible only to operators trained in electrical equipment with sufficient electrical knowledge.



- Avoid metal debris and wire ends falling into the PLC's ventilation openings during installation to prevent fire, malfunction, or misoperation;
- Ensure no obstructions on the ventilation surface after installation to avoid impaired heat dissipation, which could cause fire, malfunction, or misoperation;
- Securely connect the module to its connector and lock the hooks during installation to prevent misoperation, failure, or detachment due to improper installation.

Wiring



- Only professionals with relevant training in electrical equipment and electrical knowledge can carry out wiring on this product;
- Disconnect all external power supplies before wiring. Failure to do so may result in electric shock, equipment failure, or malfunction;
- After wiring, install the provided terminal cover before powering up and operating the product to prevent electric shock;
- Ensure proper insulation on cable terminals and maintain the required spacing between cables after installation to avoid electric shock or equipment damage.



- Disconnect the power supply before connection to avoid electric shock;
- The input voltage for this product is DC 24V; supplying power outside the DC24V±20% range can severely damage the product. Regularly check the stability of the DC power provided by the switching power supply.

Operation & Maintenance



- Only professionals with relevant training in electrical equipment and electrical knowledge can operate and maintain this product;
- Disconnect all external power supplies before cleaning modules or adjusting terminal and connector bolts to prevent electric shock.
- Disconnect all external power supplies before removing or installing modules or connecting/disconnecting communication cables. Incomplete disconnection may cause electric shock or misoperation.

Safety Recommendations

- Carefully consider the functionality of field manual devices or other alternatives at locations where operators directly contact mechanical parts, such as loading/unloading stations or automated mechanical operation areas. These should be independent of the PLC and capable of initiating or interrupting the system's automatic operation.
- When modifying programs while the system is running, consider implementing locking or other protective measures to ensure that only authorized personnel can make necessary changes.

Disposal



- Dispose of them according to industrial waste treatment standards. Waste batteries should be disposed of separately in accordance with local laws;
- Treat and recycle scrapped equipment and products according to industrial waste treatment standards to avoid environmental pollution.

1 Product Information

1.1 Naming Rules and Nameplate

VH – 08 08 E TP
 ① ② ③ ④

| |
|---|
| ①Product information VH: VEICHI slim series IO module |
| ①IO input points 08: 8 points |
| ②IO output points 08: 8 points |
| ③Module type E: Logic IO expansion module |
| ④Output type R: Relay output TP: Transistor output (source) TN: Transistor output (sink) |





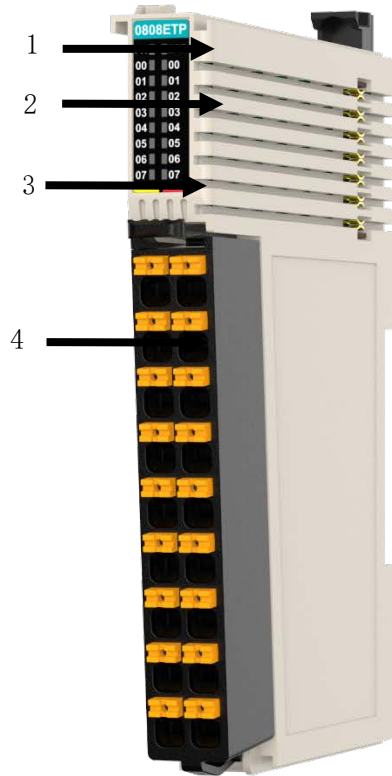

Based on the naming rules and nameplate information, the relevant ordering data for this product is shown in the table below:

| Model | Description | Code | Model |
|------------|---|------|----------------------------------|
| VH-0808ETP | VH 8-channel DI/VH 8-channel source type DO | | VH series PLC, VH series coupler |

1.2 Component



| No. | Interface | Definition | | | |
|-----|----------------------|---|------------------------|--|-------------------------|
| 1 | Signal indicator | PR (POWER+RUN) | Power/Run indicator | On (Green) | Normal |
| | | | | Off | Module abnormal |
| | | | | Flash (Green) | Module ready or stopped |
| | | ERR | Error indicator | On (Red) | Module error |
| 2 | IO signal indicator | Left side (00~07) indicators correspond to 8 input channels, lit when input is active; Right side (00~07) indicators correspond to 8 output channels, lit when output is active. | | | |
| 3 | Color identification |  Yellow: IO input | |  Red: IO output | |
| | |  Green: Analog input | |  Blue: Analog output | |
| | |  Orange: Temperature input | | | |
| 4 | User terminal | Refer to the terminal definition section for details. | | | |

1.3 Technical Specification

1.3.1 Power Specification

| Item | Specification |
|-------------------------------------|---------------------------|
| Terminal input power rated voltage | 24VDC (20.4VDC ~ 28.8VDC) |
| Terminal input power rated current | 2A (typical at 24V) |
| Bus input power rated voltage | 5VDC (4.75VDC ~ 5.25VDC) |
| Bus input power rated current | 85mA (typical at 5V) |
| Power isolation | 24V and 5V isolated |
| Terminal output power rated voltage | None |
| Terminal output power rated current | None |
| Module hot swap | N/A |

1.3.2 Input Specification

| Item | Specification |
|-------------------------------|---|
| Input type | Digital input |
| Input method | Source type |
| Input channel | 8 |
| Input voltage level | 24VDC±10% (21.6VDC ~ 26.4VDC) |
| Input current (typical) | 4mA (typical at 24V) |
| ON voltage | >15VDC |
| OFF voltage | <5VDC |
| Hardware response time ON/OFF | 100uS/ 100uS |
| Software filter time | Yes |
| Input impedance | Reference value: 5.3k to 5.6k |
| Isolated | Yes |
| Input display | When it is the driving state, the input indicator is ON (controlled by software) |
| Input derating | 75% derating at 55°C (ON input points not exceeding 12), or 10°C derating when all output points are ON. |

1.3.3 Output Specification

| Item | Specification |
|-------------------------------|---|
| Output type | Digital output, transistor output |
| Output mode | Source type |
| Output channel | 8 |
| Voltage level | 24VDC±10% (21.6 VDC ~ 26.4 VDC) |
| Output load (resistive load) | 0.5A/terminal, 2A/module |
| Output load (inductive load) | 7.2W/terminal, 12W/module |
| Output load (lamp load) | 5W/terminal, 18W/module |
| Hardware response time ON/OFF | 100us/ 100us |
| OFF leakage current | 10uA |
| Switching frequency | Resistive load: 100Hz, inductive load: 0.5Hz, lamp load: 10Hz |

| | |
|-----------------|---|
| Isolated | Yes |
| Output display | When it is the driving state, the output indicator is ON (controlled by software) |
| Output derating | 50% derating at 55°C (ON output current not exceeding 1A), or 10°C derating when all output points are ON |
| Protection | Short circuit protection, over-current protection |

1.3.4 Software Specification

| Item | Specification |
|--|---|
| Software input filter time | 0.25ms*N (N=0~255), with a common filter parameter for every group of 8 channels. |
| Input port exception detection and indication | None |
| Input channel logic level | N/A |
| Output status on fault | Clear, hold current value, output preset value |
| Preset value on fault | 0 or 1 |
| Output port exception detection and indication | None |
| Output channel logic level | N/A |
| Independent channel enable configuration | N/A |
| Diagnostic reporting feature | N/A |
| Under shutdown mode | Outputs do not refresh, while inputs support refreshing in Safeop. |
| IO mapping | Support bit-wise, byte-wise, and word-wise IO mapping methods |

2 Mechanical Installation

2.1 Installation Dimension

2.1.1 Module

Installation dimension information is shown in the following figure, and the unit is millimeter (mm):

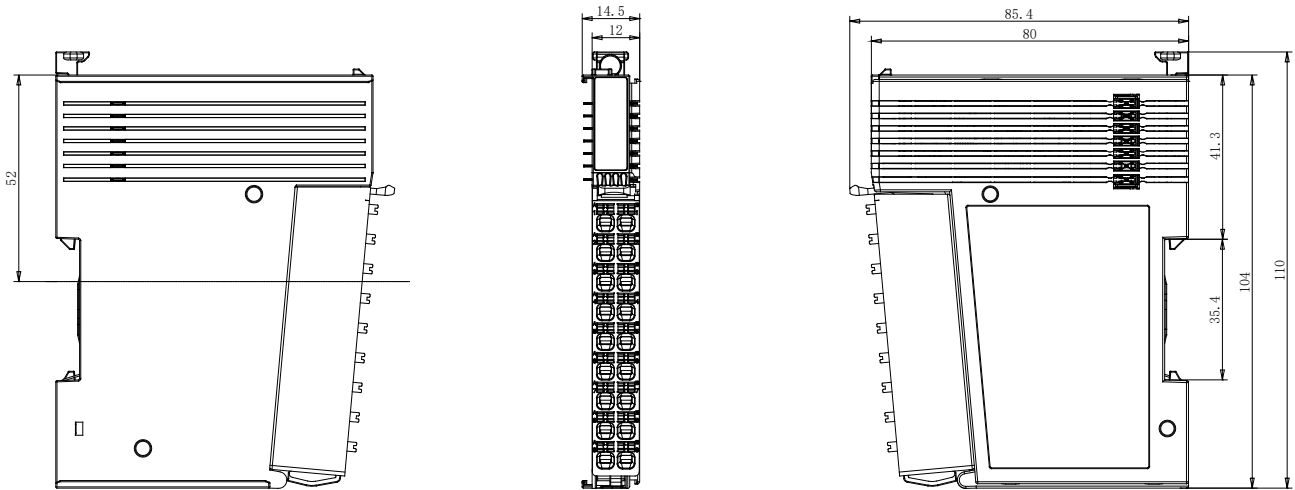

Ensure at least 10mm of clearance above the product to accommodate the latch's movement.

2.2 Installation Method

2.2.1 Module-to-Module Installation

Modules are mounted by sliding to the correct positions by the top and bottom lead rails.

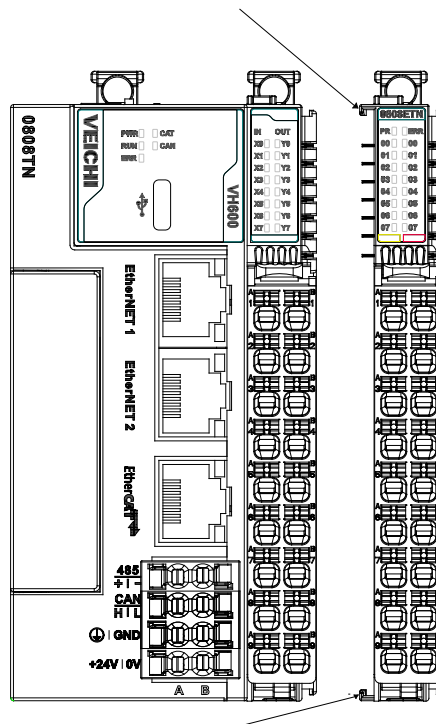

2.2.2 Module Installation on Rail

The module is installed using the DIN lead rail. When installing, align the module to the DIN lead rail, press the module in the direction indicated by the arrow, and there will be an obvious clipping sound if it is in place, as shown in the figure below:

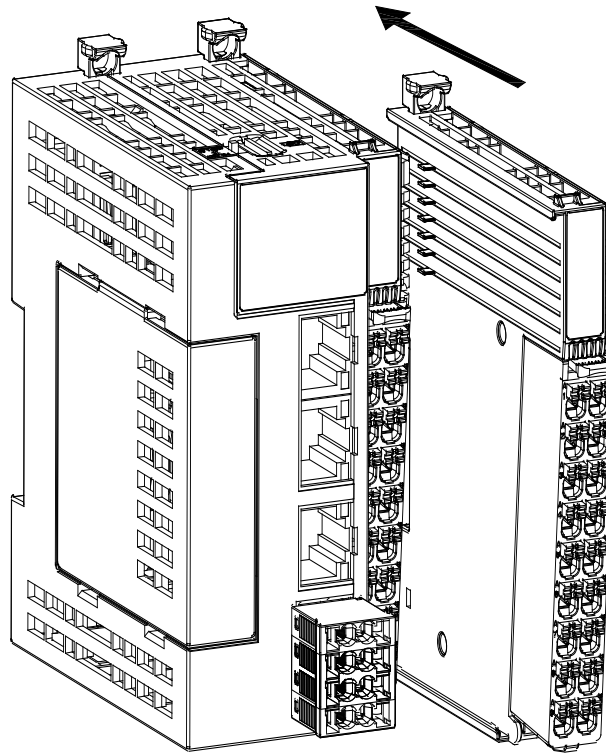

Description: Depress the rail latch to open it, then place the module on the DIN lead rail and press down on the latch to secure it. Install a DIN snap on both the master and modules. When installing the rail snap, hook the bottom of it to the bottom of the rail and then rotate the snap so that the top end of it is hooked to the top end of the rail, and finally tighten the screws to lock the rail snap.

2.2.3 Disassembly

Depress the rail latch with your finger and then pull the module away from the DIN lead rail.

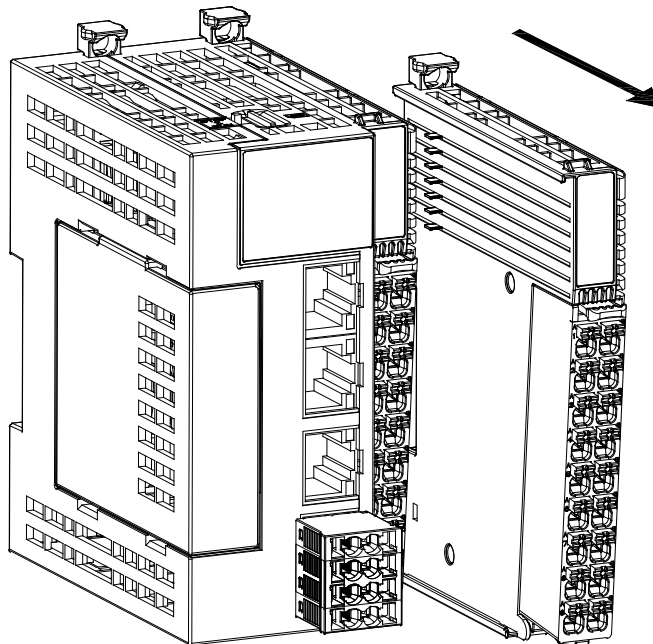

3 Electrical Installation

3.1 Cable Selection

In the following table, the lug diameter is for reference only, which can be calculated reasonably according to actual use and adjusted separately.

| Name | Diameter | |
|-------------|----------|----------|
| | GB/mm2 | ANSI/AWG |
| Tubular lug | 0.3 | 22 |
| | 0.5 | 20 |
| | 0.75 | 18 |
| | 1.0 | 18 |
| | 1.5 | 16 |

If other tubular lugs are used, press them to the twisted cables. The shape and size requirements are as shown in the following figure.

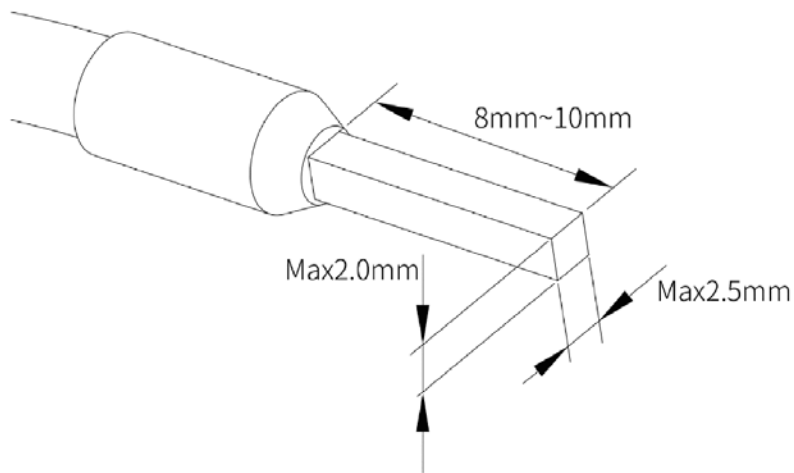

3.2 Terminal Definition



| Left Indicator | Left Signal | Left Terminal | Right Terminal | Right Signal | Right Indicator |
|----------------|-------------|---------------|----------------|--------------|-----------------|
| 00 | X0 | A1 | B1 | Y0 | 00 |
| 01 | X1 | A2 | B2 | Y1 | 01 |
| 02 | X2 | A3 | B3 | Y2 | 02 |
| 03 | X3 | A4 | B4 | Y3 | 03 |
| 04 | X4 | A5 | B5 | Y4 | 04 |
| 05 | X5 | A6 | B6 | Y5 | 05 |
| 06 | X6 | A7 | B7 | Y6 | 06 |
| 07 | X7 | A8 | B8 | Y7 | 07 |
| / | 24V | A9 | B9 | COM | / |

3.3 User Terminal Wiring

3.3.1 Input Terminal Wiring

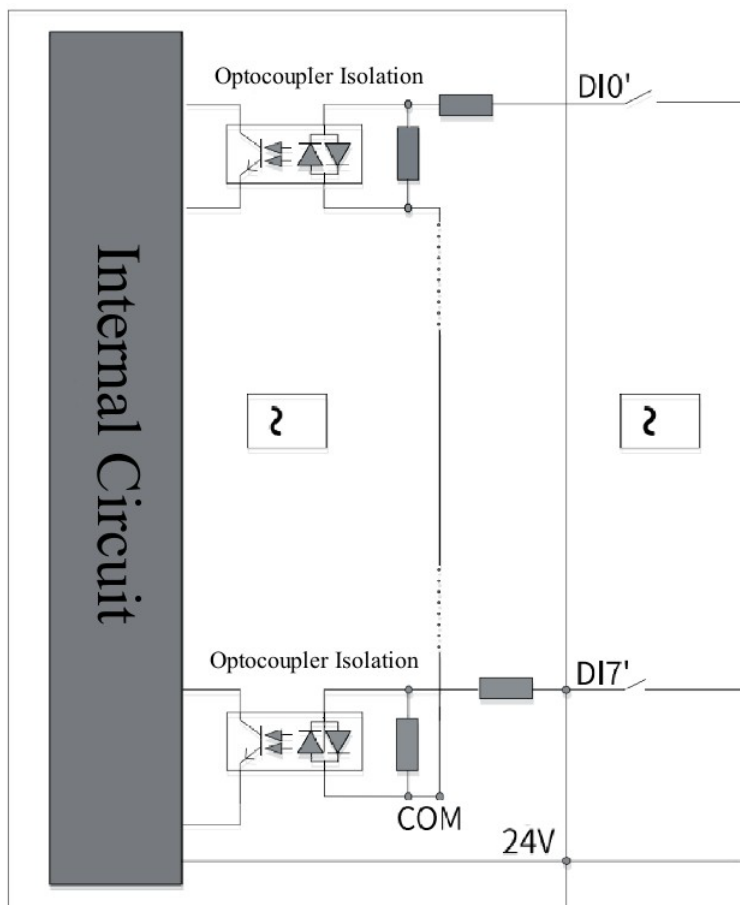

Note: The VH-0808ETP module is fixed with source type input configuration.

3.3.2 Output Terminal Wiring

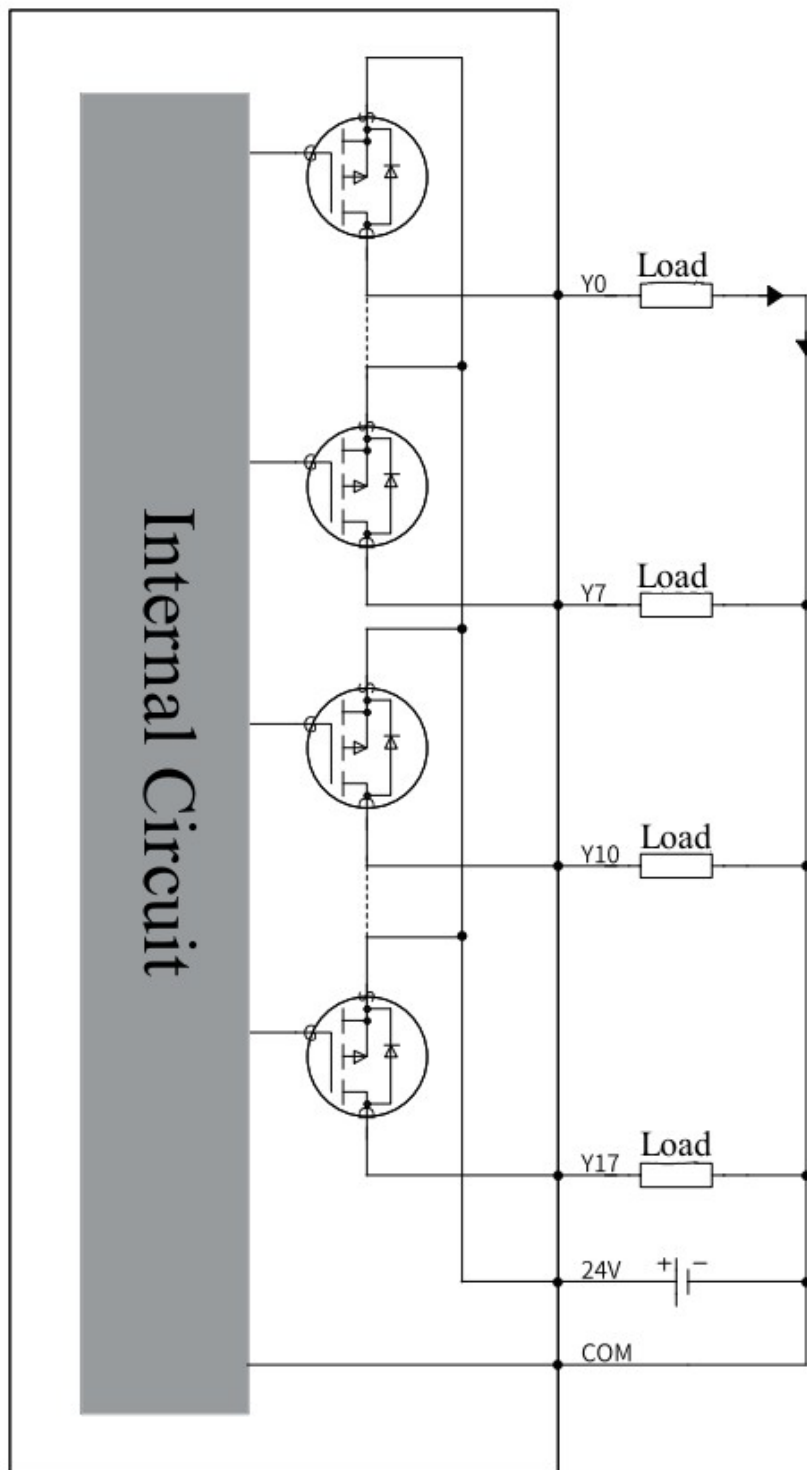

4 Module Programming

4.1 VEICHI CODESYS Programming Software

4.1.1 Create a New Project

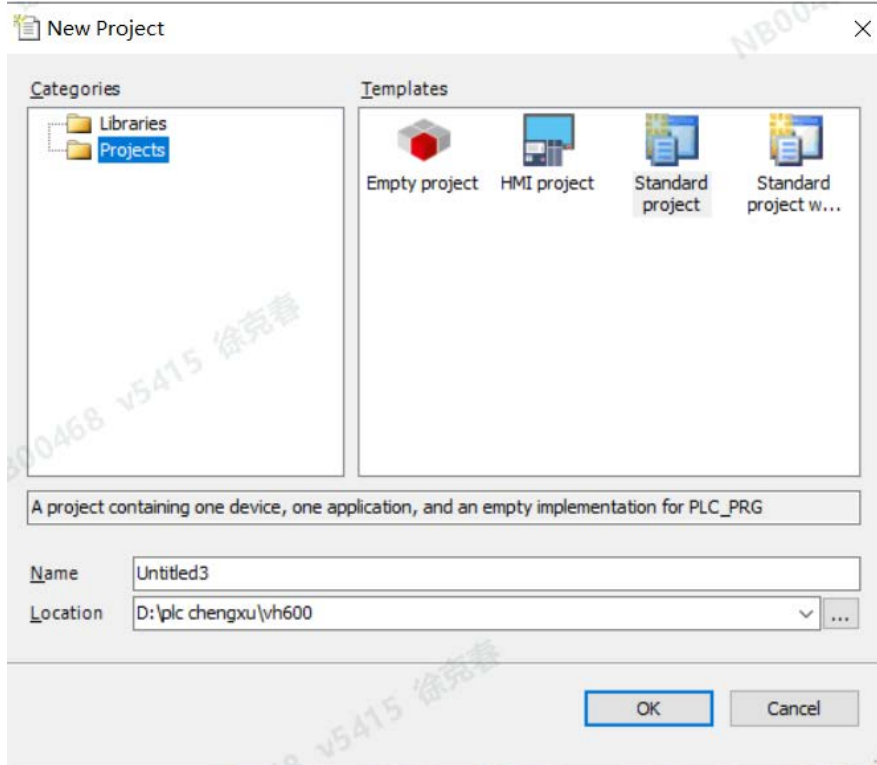

4.1.2 Add a New Module

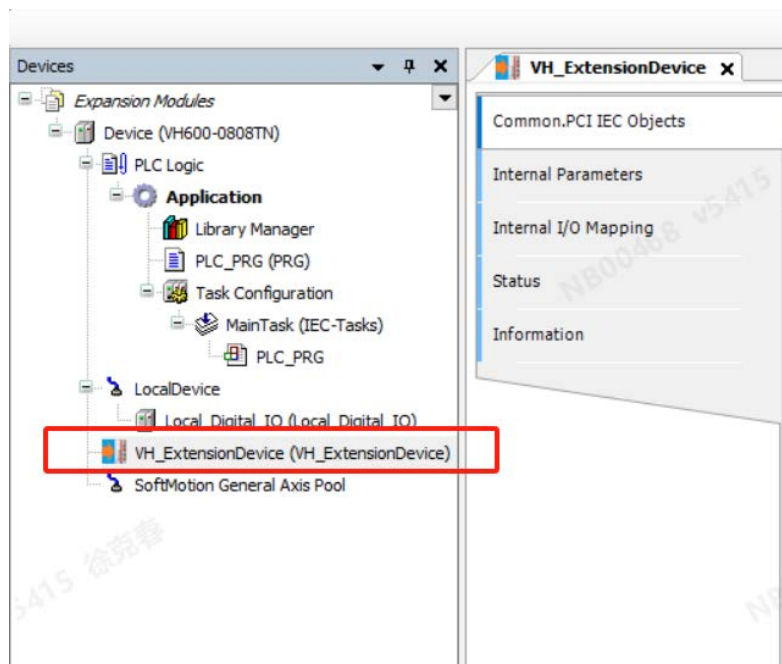

Right-click it and select "Add Device."

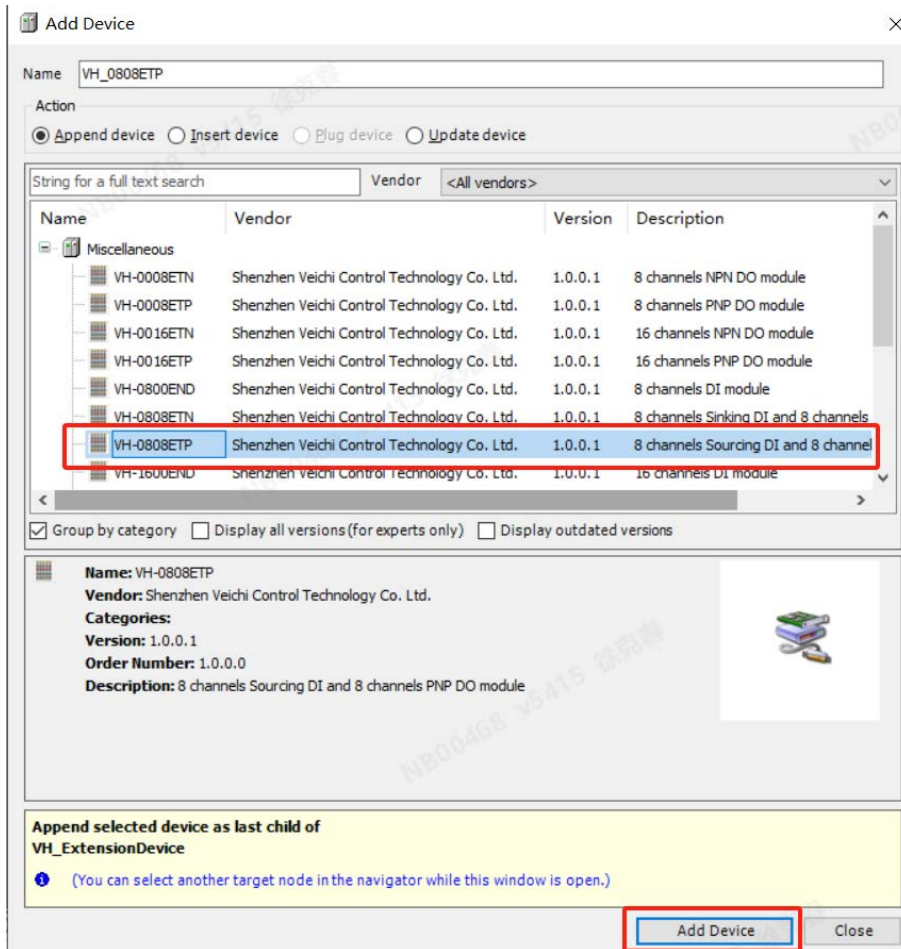
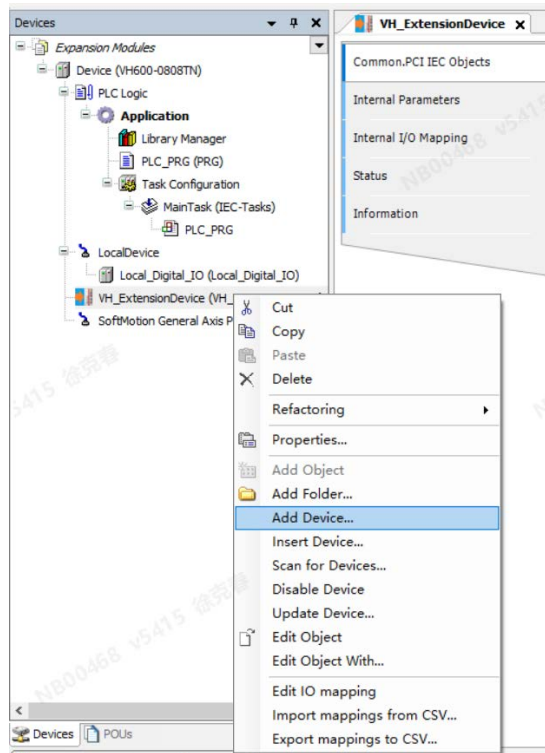

Click the "Add Device."

4.1.3 Configure Parameters

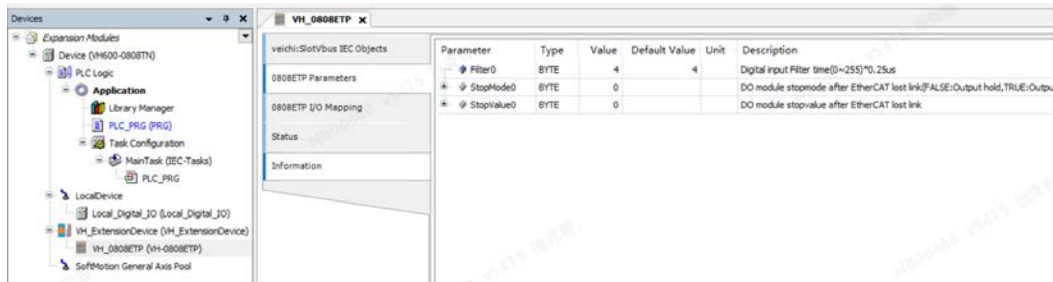

4.1.4 Automatic Scanning

The VH600 allows manual slot configuration or module scanning after installing the right expansion modules. The configuration and sequence of expansion modules must match the physical setup; otherwise, an alarm will warn of a mismatch between configuration and connection.

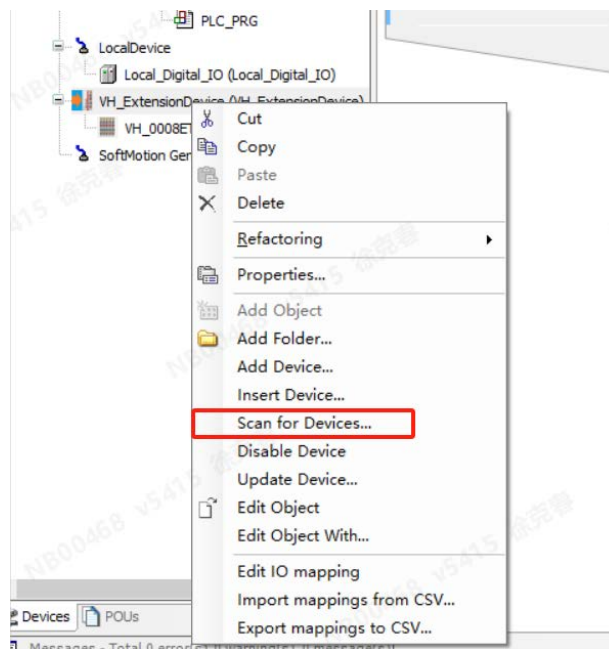

4.1.5 IO Mapping

VH600 defaults to no mapping relationship, so it is necessary to map the registers that need to be controlled and monitored to the soft elements before use; otherwise, users cannot operate them.

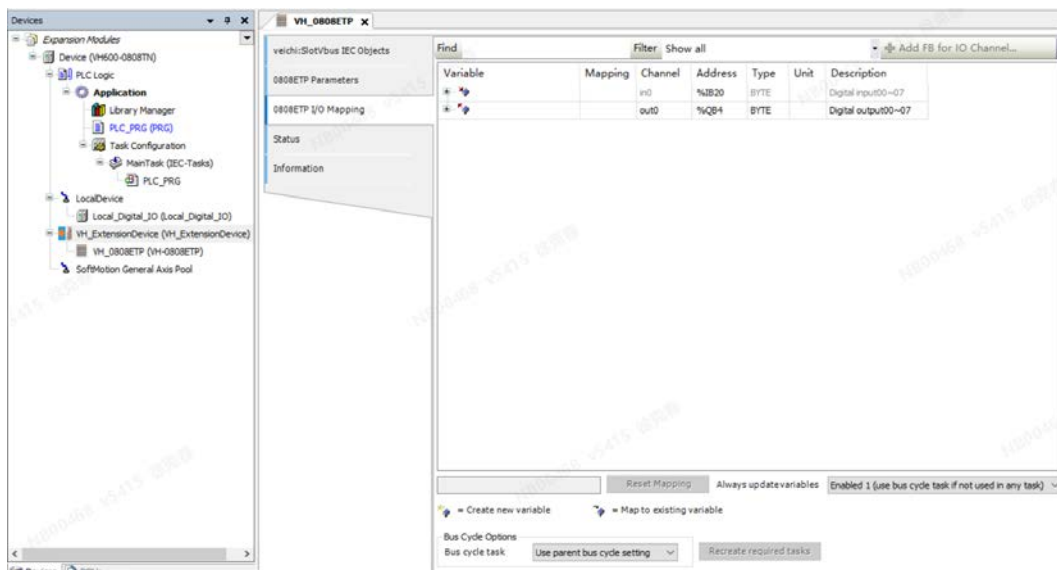

4.1.6 Set Parameters

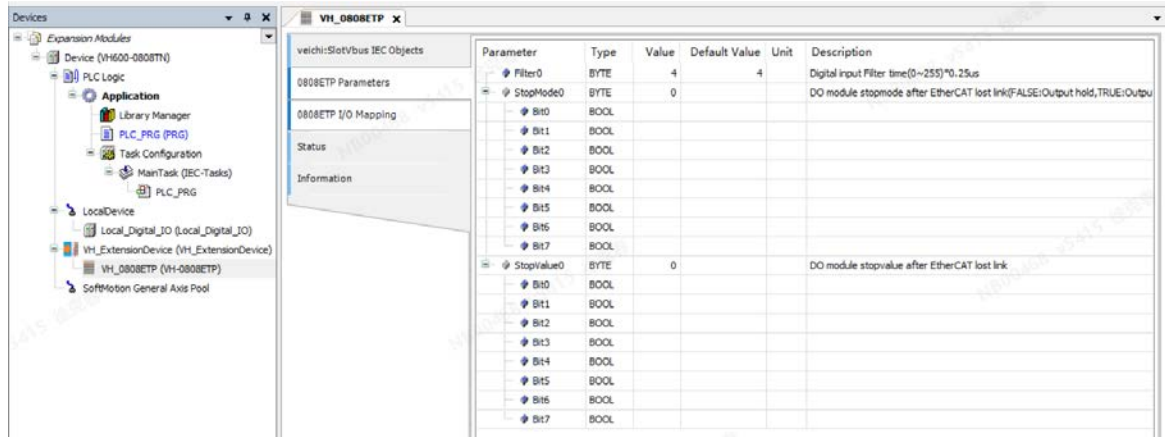

4.1.7 Write User Program

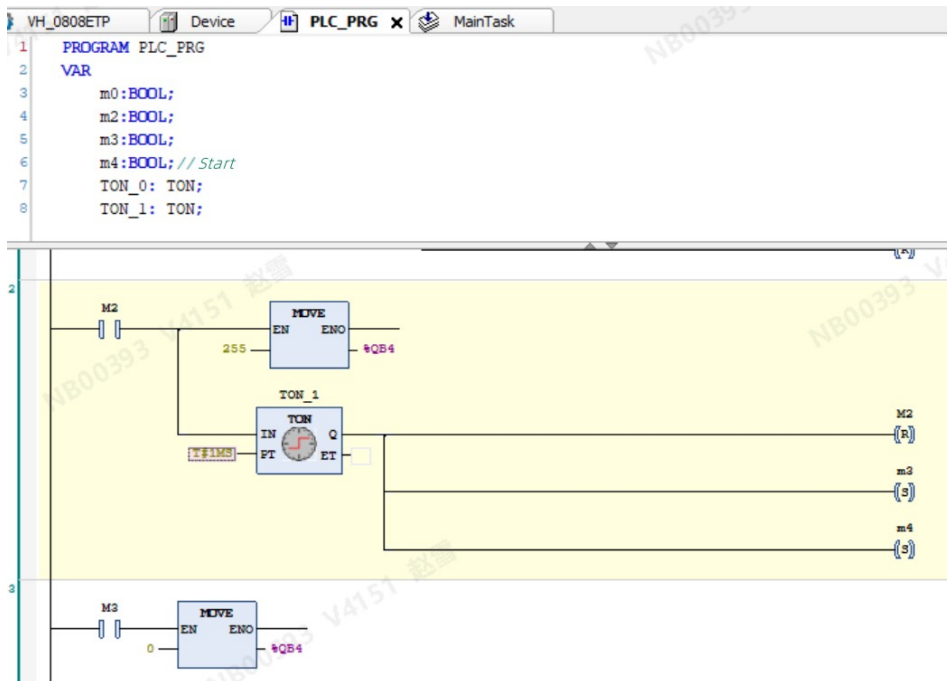

4.1.8 Compile, Download, and Run

If the compilation is without errors, download and run the program.

